



Thread Milling Tools

METRIC

CONTENTS	PAGE
THREAD MILLING - INTRODUCTION ORDERING CODE	3
SOLID THREAD MILLING TOOLS	4
ISO - HELICAL FLUTES	5-6
UN - HELICAL FLUTES	7-8
NPT - HELICAL FLUTES	9
NPTF - HELICAL FLUTES	10
BSP - HELICAL FLUTES	11
BSPT - HELICAL FLUTES	12
PARTIAL PROFILE - SINGLE TOOTH	13
ISO - 3 TEETH 2D	14
ISO - 3 TEETH 3D	15
UN - 3 TEETH 2D	16
UN - 3 TEETH 3D	17
UNJ, MJ -3 TEETH 3D	18
ISO - 3 TEETH (Hard Materials)	19
UN - 3 TEETH (Hard Materials)	20
ISO - STRAIGHT FLUTES	21
UN - STRAIGHT FLUTES	22
NPT, NPTF - STRAIGHT FLUTES	23
BSP, BSPT - STRAIGHT FLUTES	24
CHAMFERS	25
TAPER END MILL & 45° CHAMFER	26
TECHNICAL SECTION	
THREAD MILLING CYCLES	27
MACHINING CONDITIONS	28
TROUBLE SHOOTING	29

EROJET IS A CUTTING TOOLS MANUFACTURER OF THREAD MILLING, THREAD TURNING AND GROOVING TOOLS

EROJET's tools reputation is built by advanced manufacturing processes with the high professionalism, efficiently and reliably, that's **certified according to ISO 9001**.

EROJET provides the right solution for specific needs, with outstanding customer service, Technical consultation and fast delivery.

THREAD MILLING ADVANTAGES

- ✓ One tool can be used for right hand and left hand thread.
- ✓ One tool can produce a wide variety of thread diameters of the same pitch.
- ✓ Produces threads with high surface finish, sizes and accuracy.
- ✓ Full thread to the bottom of hole.
- ✓ Small machines can produce large threads due to less spindle torque.
- ✓ Less cutting pressure for thin wall parts.
- ✓ Eliminates the need of removing broken taps.



EROJET ORDERING CODE - SOLID THREAD MILLING

TMG	06	039	L10	0.8	ISO	K520C				
SOLID THREAD MILLING INTERNAL TOOLS	SHANK DIAMETER (MM)	CUTTING DIAMETER	TOOL CUTTING LENGTH	PITCH	THREAD STANDARD	CARBIDE GRADE				
PARTIAL PROFILE : TMP = SINGLE TOOTH FULL PROFILE : TMC = 3 TEETH TMCL = 3 TEETH -LONG TMD = 3 TEETH - HM TMG = REGULAR -helical TMGB = Through Coolant TMX = REULAR-straight CMP = Chamfer PM = Preparation	Ø 3	Ø 3.9 MM	L10=10 MM	0.8 MM		ISO UN BSP BSPT NPT NPTF UNJ MJ	K520C			
	Ø 4			<table border="1"> <tr> <th>MM</th> <th>TPI</th> </tr> <tr> <td>0.35-3.0</td> <td>72-8</td> </tr> </table>	MM			TPI	0.35-3.0	72-8
	MM				TPI					
	0.35-3.0			72-8						
Ø 6										
Ø 8										
Ø 10										
Ø 12										
Ø 16										
Ø 20										

SOLID THREAD MILLING TOOLS

STANDARD - HELICAL FLUTES

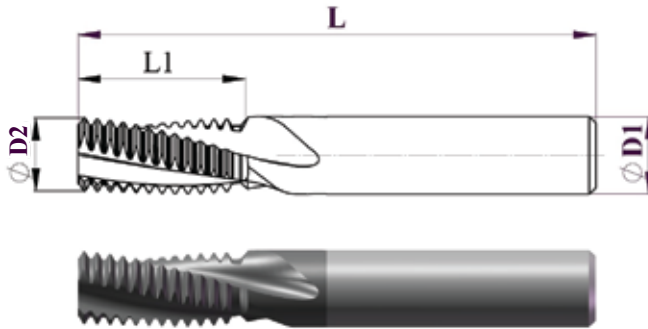

STANDARD TAPER - HELICAL FLUTES

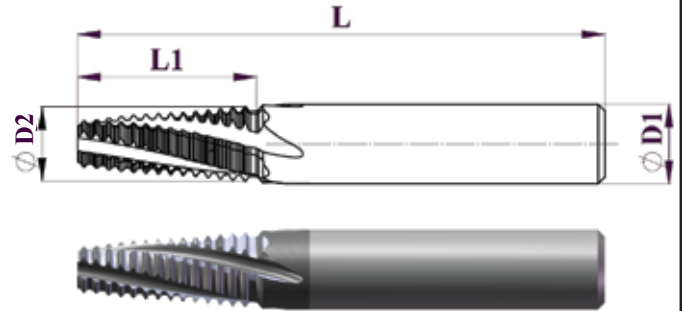

MINIATURE TOOLS - FOR HARD MATERIAL

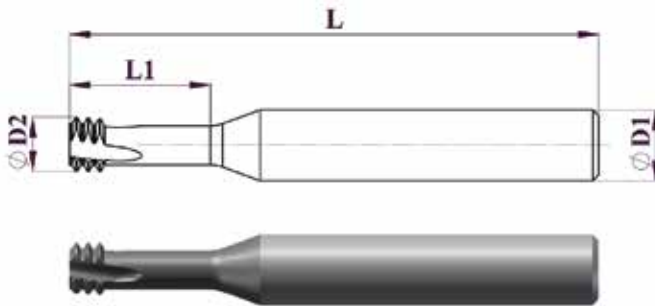

MINIATURE TOOLS - GENERAL PURPOSE

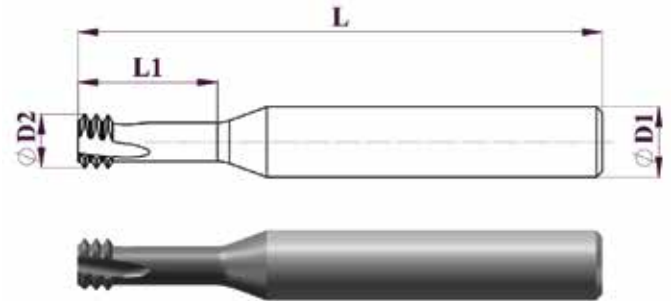

PARTIAL PROFILE

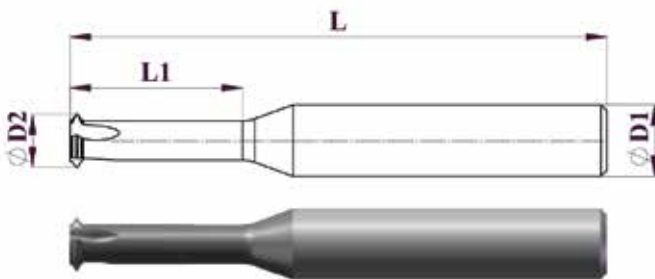

HELICAL FLUTES WITH COOLANT

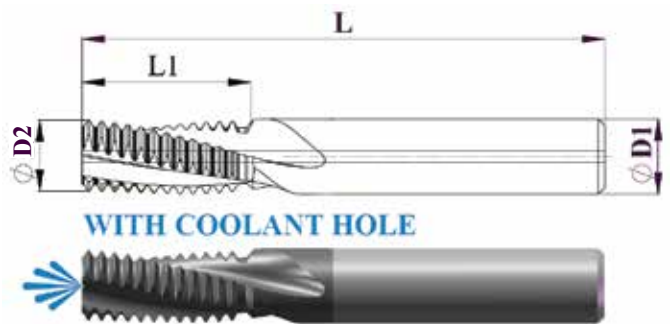

STANDARD - STRAIGHT FLUTES

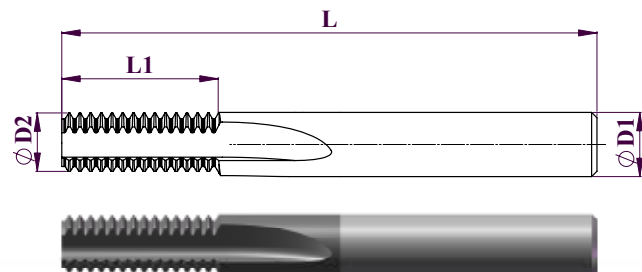

STANDARD TAPER - STRAIGHT FLUTES

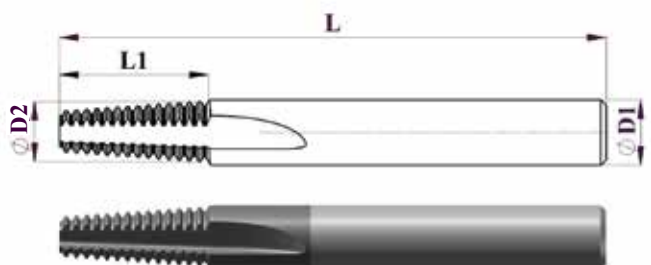

ISO METRIC

INTERNAL

ISO 965-1:1999-11
DIN13: 2005-08

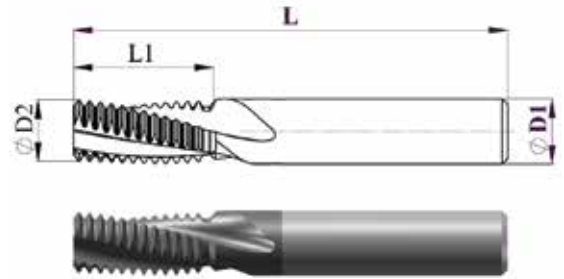
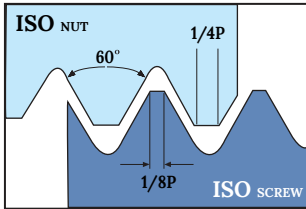

HELICAL FLUTES

	THREAD SIZE		PITCH MM	ORDERING CODE	L	L1	D1	D2	NO. OF FLUTES
	COARSE	FINE							
1		M5.0x0.5	0.50	TMG06038L10 0.5ISO	57	10.3	6	3.8	3
2		M7.0x0.5	0.50	TMG06059L10 0.5ISO	57	10.2	6	5.9	3
3	M4.5x0.75	M5.0x0.75	0.75	TMG06036L10 0.75ISO	57	10.1	6	3.6	3
4		M8.0x0.75	0.75	TMG06059L10 0.75ISO	57	10.8	6	5.9	3
5		M10.0x0.75	0.75	TMG08079L15 0.75ISO	63	15.3	8	7.9	4
6	M5.0x0.8		0.8	TMG06039L10 0.8ISO	57	10.0	6	3.9	3
7	M6.0x1.0	M7.0x1.0	1.0	TMG06048L11 1.0ISO	57	11.5	6	4.8	3
8	M6.0x1.0	M7.0x1.0	1.0	TMG06048L14 1.0ISO	57	14.5	6	4.8	3
9		M8.0x1.0	1.0	TMG06059L12 1.0ISO	57	12.5	6	5.9	3
10		M10.0x1.0	1.0	TMG08079L17 1.0ISO	63	17.5	8	7.9	4
11		M12.0x1.0	1.0	TMG10099L20 1.0ISO	73	20.5	10	9.9	4
12	M8.0x1.25	M9.0x1.25	1.25	TMG06059L14 1.25ISO	57	14.4	6	5.9	3
13	M8.0x1.25	M9.0x1.25	1.25	TMG06059L19 1.25ISO	57	19.5	6	5.9	3
14	M10.0x1.5	M11.0x1.5	1.5	TMG08079L18 1.5ISO	63	18.5	8	7.9	3
15		M13.0x1.5	1.5	TMG10099L21 1.5ISO	73	21.8	10	9.9	4
16		M15.0x1.5	1.5	TMG12119L26 1.5ISO	84	26.3	12	11.9	4
17		M20.0x1.5	1.5	TMG16159L35 1.5ISO	105	35.2	16	15.9	6
18	M12.0x1.75		1.75	TMG10092L21 1.75ISO	73	21.8	10	9.2	3
19	M14.0x2.0		2.0	TMG10099L25 2.0ISO	73	25.0	10	9.9	3
20	M16.0x2.0		2.0	TMG12119L27 2.0ISO	84	27.0	12	11.9	4
21		M20.0x2.0	2.0	TMG16159L37 2.0ISO	105	37.0	16	15.9	5
22	M20.0x2.5		2.5	TMG16159L36 2.5ISO	105	36.3	16	15.9	5
23	M24.0x3.0	M27.0x3.0	3.0	TMG16159L40 3.0ISO	105	40.5	16	15.9	3
24	M27.0x3.0		3.0	TMG20199L43 3.0ISO	105	43.0	20	19.9	4

ISO METRIC

INTERNAL

ISO 965-1:1999-11
DIN13: 2005-08

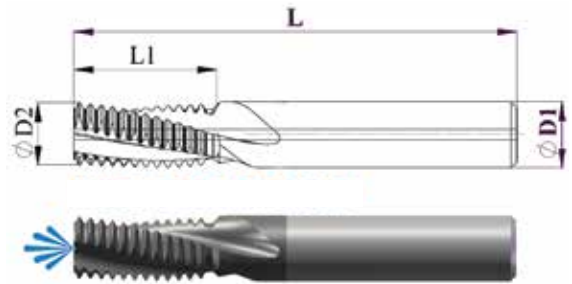
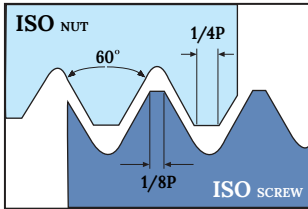

HELICAL FLUTES WITH COOLANT HOLE

	THREAD SIZE		PITCH MM	ORDERING CODE	L	L1	D1	D2	NO. OF FLUTES
	COARSE	FINE							
1		M5.0x0.5	0.50	TMGB06038L10 0.5ISO	57	10.3	6	3.8	3
2		M7.0x0.5	0.50	TMGB06059L10 0.5ISO	57	10.2	6	5.9	3
3	M4.5x0.75	M5.0x0.75	0.75	TMGB06036L10 0.75ISO	57	10.1	6	3.6	3
4		M8.0x0.75	0.75	TMGB06059L10 0.75ISO	57	10.8	6	5.9	3
5		M10.0x0.75	0.75	TMGB08079L15 0.75ISO	63	15.3	8	7.9	4
6	M5.0x0.8		0.8	TMGB06039L10 0.8ISO	57	10.0	6	3.9	3
7	M6.0x1.0	M7.0x1.0	1.0	TMGB06048L11 1.0ISO	57	11.5	6	4.8	3
8	M6.0x1.0	M7.0x1.0	1.0	TMGB06048L14 1.0ISO	57	14.5	6	4.8	3
9		M8.0x1.0	1.0	TMGB06059L12 1.0ISO	57	12.5	6	5.9	3
10		M10.0x1.0	1.0	TMGB08079L17 1.0ISO	63	17.5	8	7.9	4
11		M12.0x1.0	1.0	TMGB10099L20 1.0ISO	73	20.5	10	9.9	4
12	M8.0x1.25	M9.0x1.25	1.25	TMGB06059L14 1.25ISO	57	14.4	6	5.9	3
13	M8.0x1.25	M9.0x1.25	1.25	TMGB06059L19 1.25ISO	57	19.5	6	5.9	3
14	M10.0x1.5	M11.0x1.5	1.5	TMGB08079L18 1.5ISO	63	18.5	8	7.9	3
15		M13.0x1.5	1.5	TMGB10099L21 1.5ISO	73	21.8	10	9.9	4
16		M15.0x1.5	1.5	TMGB12119L26 1.5ISO	84	26.3	12	11.9	4
17		M20.0x1.5	1.5	TMGB16159L35 1.5ISO	105	35.2	16	15.9	6
18	M12.0x1.75		1.75	TMGB10092L21 1.75ISO	73	21.8	10	9.2	3
19	M14.0x2.0		2.0	TMGB10099L25 2.0ISO	73	25.0	10	9.9	3
20	M16.0x2.0		2.0	TMGB12119L27 2.0ISO	84	27.0	12	11.9	4
21		M20.0x2.0	2.0	TMGB16159L37 2.0ISO	105	37.0	16	15.9	5
22	M20.0x2.5		2.5	TMGB16159L36 2.5ISO	105	36.3	16	15.9	5
23	M24.0x3.0	M27.0x3.0	3.0	TMGB16159L40 3.0ISO	105	40.5	16	15.9	3
24	M27.0x3.0		3.0	TMGB20199L43 3.0ISO	105	43.0	20	19.9	4

UN (UNC, UNF, UNEF) INTERNAL

ANSI B1.1 - 1982

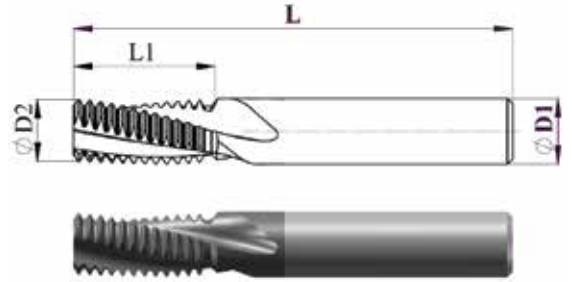
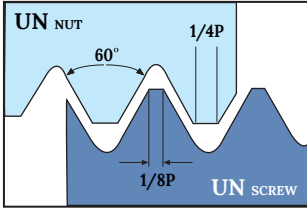

HELICAL FLUTES

	THREAD SIZE			PITCH TPI	ORDERING CODE	L	L1	D1	D2	NO. OF FLUTES
	COARSE UNC	FINE UNF	EXTRA FINE UNEF							
1			5/16"	32	TMG06059L14 32UN	57	14.0	6	5.9	3
2			3/8"	32	TMG08079L18 32UN	63	18.0	8	7.9	3
3		1/4"		28	TMG06051L12 28UN	57	12.2	6	5.1	3
4			7/16"-1/2"	28	TMG08079L15 28UN	63	15.8	8	7.9	4
5		5/16"		24	TMG06059L10 24UN	57	10.8	6	5.9	3
6		3/8"		24	TMG08079L15 24UN	63	15.3	8	7.9	4
7		9/16", 5/8"		24	TMG12119L22 24UN	84	22.7	12	11.9	4
8	1/4"			20	TMG06048L12 20UN	57	12.0	6	4.8	3
9		7/16"		20	TMG08079L19 20UN	63	19.7	8	7.9	3
10		1/2"		20	TMG10099L22 20UN	73	22.5	10	9.9	4
11			3/4"-1"	20	TMG12119L26 20UN	84	26.0	12	11.9	4
12	5/16"			18	TMG06057L16 18UN	57	16.0	6	5.7	3
13		9/16", 5/8"		18	TMG10099L23 18UN	73	23.5	10	9.9	4
14	3/8"			16	TMG08068L18 16UN	63	18.2	8	6.8	3
15		3/4"		16	TMG12119L26 16UN	84	26.2	12	11.9	4
16	7/16"			14	TMG08078L20 14UN	63	20.8	8	7.8	3
17		7/8"		14	TMG12119L24 14UN	84	24.5	12	11.9	4
18	1/2"			13	TMG10093L24 13UN	73	24.4	10	9.3	3
19	9/16"			12	TMG12106L26 12UN	84	26.4	12	10.6	4
20		1"		12	TMG16159L39 12UN	105	39.1	16	15.9	5
21	5/8"			11	TMG12115L31 11UN	84	31.1	12	11.5	3
22	3/4"			10	TMG16143L36 10UN	105	36.8	16	14.3	4
23	7/8"			9	TMG16159L40 9UN	105	40.9	16	15.9	4
24	1"			8	TMG20197L42 8UN	105	42.8	20	19.7	4

UN (UNC, UNF, UNEF) INTERNAL

ANSI B1.1 - 1982

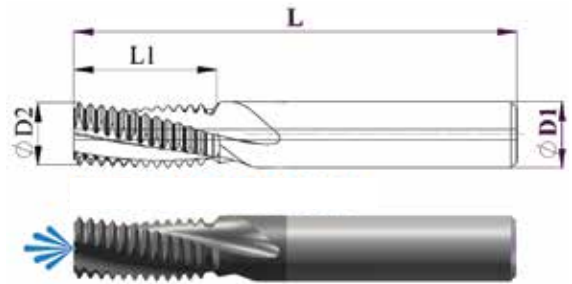
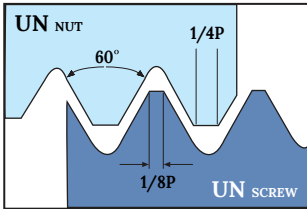

HELICAL FLUTES WITH COOLANT HOLE

	THREAD SIZE			PITCH TPI	ORDERING CODE	L	L1	D1	D2	NO. OF FLUTES
	COARSE UNC	FINE UNF	EXTRA FINE UNEF							
1			5/16"	32	TMGB06059L14 32UN	57	14.0	6	5.9	3
2			3/8"	32	TMGB08079L18 32UN	63	18.0	8	7.9	3
3		1/4"		28	TMGB06051L12 28UN	57	12.2	6	5.1	3
4			7/16"-1/2"	28	TMGB08079L15 28UN	63	15.8	8	7.9	4
5		5/16"		24	TMGB06059L10 24UN	57	10.8	6	5.9	3
6		3/8"		24	TMGB08079L15 24UN	63	15.3	8	7.9	4
7		9/16", 5/8"		24	TMGB12119L22 24UN	84	22.7	12	11.9	4
8	1/4"			20	TMGB06048L12 20UN	57	12.0	6	4.8	3
9		7/16"		20	TMGB08079L19 20UN	63	19.7	8	7.9	3
10		1/2"		20	TMGB10099L22 20UN	73	22.5	10	9.9	4
11			3/4"-1"	20	TMGB12119L26 20UN	84	26.0	12	11.9	4
12	5/16"			18	TMGB06057L16 18UN	57	16.0	6	5.7	3
13		9/16", 5/8"		18	TMGB10099L23 18UN	73	23.5	10	9.9	4
14	3/8"			16	TMGB08068L18 16UN	63	18.2	8	6.8	3
15		3/4"		16	TMGB12119L26 16UN	84	26.2	12	11.9	4
16	7/16"			14	TMGB08078L20 14UN	63	20.8	8	7.8	3
17		7/8"		14	TMGB12119L24 14UN	84	24.5	12	11.9	4
18	1/2"			13	TMGB10093L24 13UN	73	24.4	10	9.3	3
19	9/16"			12	TMGB12106L26 12UN	84	26.4	12	10.6	4
20		1"		12	TMGB16159L39 12UN	105	39.1	16	15.9	5
21	5/8"			11	TMGB12115L31 11UN	84	31.1	12	11.5	3
22	3/4"			10	TMGB16143L36 10UN	105	36.8	16	14.3	4
23	7/8"			9	TMGB16159L40 9UN	105	40.9	16	15.9	4
24	1"			8	TMGB20197L42 8UN	105	42.8	20	19.7	4

NPT

INTERNAL / EXTERNAL

ANSI/ASME B 1.20.1-1983

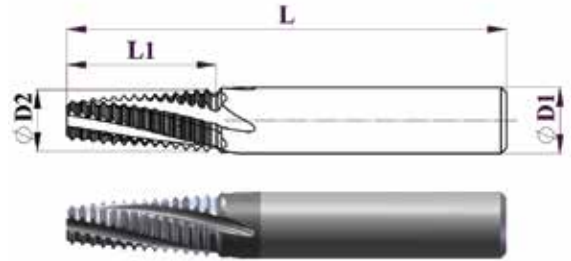
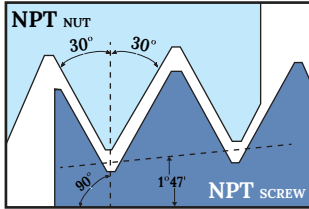

HELICAL FLUTES

	THREAD SIZE	PITCH TPI	ORDERING CODE	L	L1	D1	D2	NO. OF FLUTES
1	1/16"	27	TMG06059L09 27NPT	57	9.8	6	5.9	3
2	1/8"	27	TMG08077L10 27NPT	63	10.9	8	7.7	3
3	1/4"-3/8"	18	TMG10099L16 18NPT	73	16.4	10	9.9	4
4	1/2"	14	TMG12119L20 14NPT	84	20.8	12	11.9	4
5	1/2"	14	TMG16159L20 14NPT	93	20.8	16	15.9	4
6	1"-2"	11.5	TMG20199L29 11.5NPT	105	29.7	20	19.9	4
7	2 1/2"-6"	8	TMG20199L38 8NPT	105	38.1	20	19.9	4

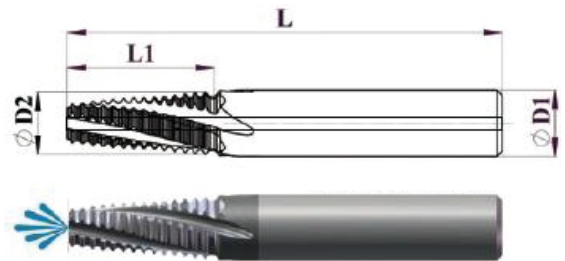

HELICAL FLUTES WITH COOLANT HOLE

	THREAD SIZE	PITCH TPI	ORDERING CODE	L	L1	D1	D2	NO. OF FLUTES
1	1/16"	27	TMGB06059L09 27NPT	57	9.8	6	5.9	3
2	1/8"	27	TMGB08077L10 27NPT	63	10.9	8	7.7	3
3	1/4"-3/8"	18	TMGB10099L16 18NPT	73	16.4	10	9.9	4
4	1/2"	14	TMGB12119L20 14NPT	84	20.8	12	11.9	4
5	1/2"	14	TMGB16159L20 14NPT	93	20.8	16	15.9	4
6	1"-2"	11.5	TMGB20199L29 11.5NPT	105	29.7	20	19.9	4
7	2 1/2"-6"	8	TMGB20199L38 8NPT	105	38.1	20	19.9	4

NPTF

INTERNAL / EXTERNAL

ANSI B 1.20.3-1976

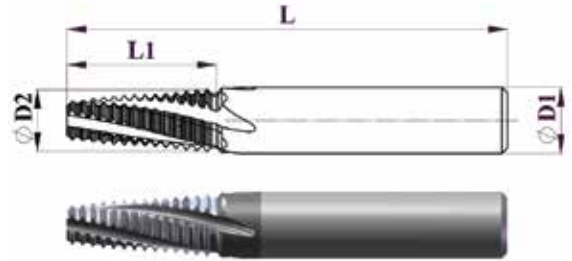
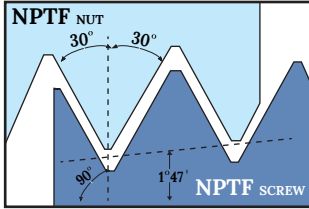

HELICAL FLUTES

	THREAD SIZE	PITCH TPI	ORDERING CODE	L	L1	D1	D2	NO. OF FLUTES
1	1/16"	27	TMG06059L09 27NPTF	57	9.9	6	5.9	3
2	1/8"	27	TMG08077L10 27NPTF	63	10.8	8	7.7	3
3	1/4"-3/8"	18	TMG10099L16 18NPTF	73	16.2	10	9.9	4
4	1/2"	14	TMG12119L20 14NPTF	84	20.8	12	11.9	4
5	1"-2"	11.5	TMG20199L29 11.5NPTF	105	29.7	20	19.9	4
6	2 1/2"-6"	8	TMG20199L38 8NPTF	105	38.1	20	19.9	4

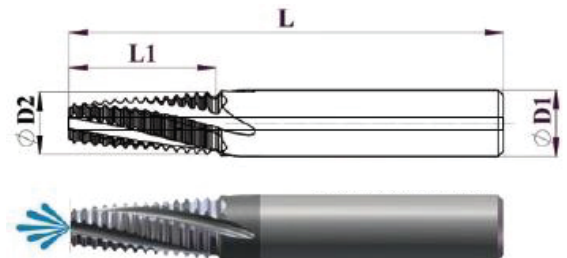

HELICAL FLUTES WITH COOLANT HOLE

	THREAD SIZE	PITCH TPI	ORDERING CODE	L	L1	D1	D2	NO. OF FLUTES
1	1/16"	27	TMGB06059L09 27NPTF	57	9.9	6	5.9	3
2	1/8"	27	TMGB08077L10 27NPTF	63	10.8	8	7.7	3
3	1/4"-3/8"	18	TMGB10099L16 18NPTF	73	16.2	10	9.9	4
4	1/2"	14	TMGB12119L20 14NPTF	84	20.8	12	11.9	4
5	1"-2"	11.5	TMGB20199L29 11.5NPTF	105	29.7	20	19.9	4
6	2 1/2"-6"	8	TMGB20199L38 8NPTF	105	38.1	20	19.9	4

BSP (G)

INTERNAL / EXTERNAL

B.S.84: 1956
ISO 228 - 1: 1994

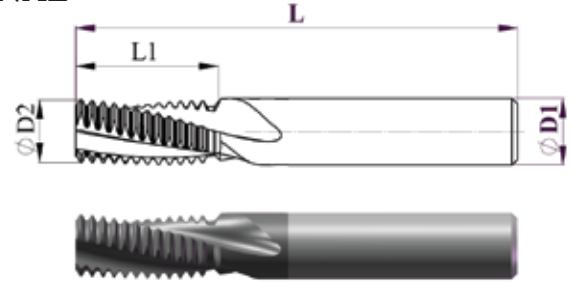
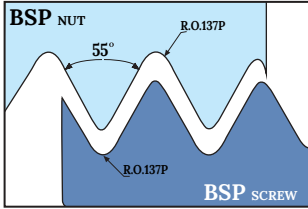

HELICAL FLUTES

	THREAD SIZE	PITCH TPI	ORDERING CODE	L	L1	D1	D2	NO. OF FLUTES
1	1/16"	28	TMG06059L11 28BSP	57	11.3	6	5.9	3
2	1/8"	28	TMG08079L14 28BSP	63	14.0	8	7.9	3
3	1/4"-3/8"	19	TMG10099L16 19BSP	73	16.6	10	9.9	4
4	1/2"-7/8"	14	TMG12119L22 14BSP	84	22.7	12	11.9	4
5	1"-2"	11	TMG16159L32 11BSP	105	32.1	16	15.9	4
6	1"-6"	11	TMG20199L40 11BSP	105	40.4	20	19.9	5

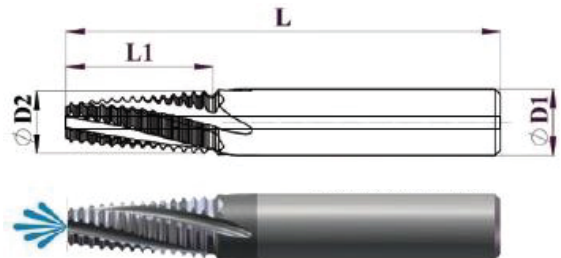

HELICAL FLUTES WITH COOLANT HOLE

	THREAD SIZE	PITCH TPI	ORDERING CODE	L	L1	D1	D2	NO. OF FLUTES
1	1/16"	28	TMGB06059L11 28BSP	57	11.3	6	5.9	3
2	1/8"	28	TMGB08079L14 28BSP	63	14.0	8	7.9	3
3	1/4"-3/8"	19	TMGB10099L16 19BSP	73	16.6	10	9.9	4
4	1/2"-7/8"	14	TMGB12119L22 14BSP	84	22.7	12	11.9	4
5	1"-2"	11	TMGB16159L32 11BSP	105	32.1	16	15.9	4
6	1"-6"	11	TMGB20199L40 11BSP	105	40.4	20	19.9	5

BSPT (Rc) INTERNAL / EXTERNAL

B.S.21: 1985

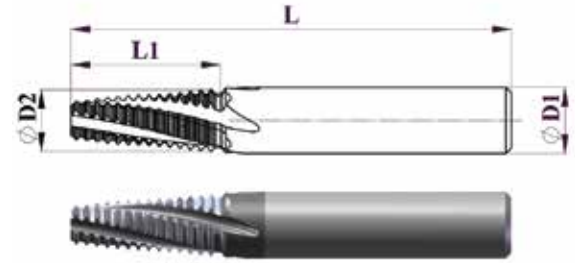
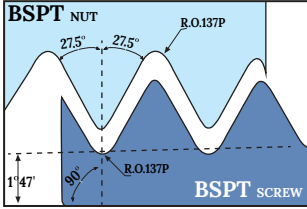

HELICAL FLUTES

	THREAD SIZE	PITCH TPI	ORDERING CODE	L	L1	D1	D2	NO. OF FLUTES
1	1/16"	28	TMG06059L11 28BSPT	57	11.3	6	5.9	3
2	1/8"	28	TMG08079L14 28BSPT	63	14.0	8	7.9	3
3	1/4"-3/8"	19	TMG10099L16 19BSPT	73	16.6	10	9.9	4
4	1/2"-7/8"	14	TMG12119L22 14BSPT	84	22.7	12	11.9	4
5	1"-2"	11	TMG16159L32 11BSPT	105	32.1	16	15.9	4
6	1"-6"	11	TMG20199L40 11BSPT	105	40.4	20	19.9	5

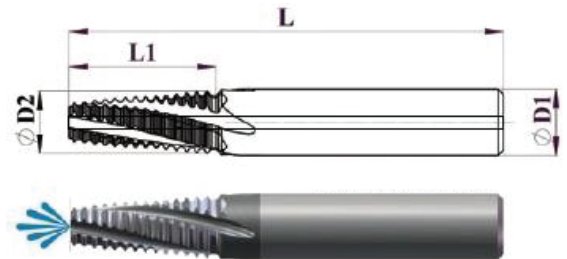

HELICAL FLUTES WITH COOLANT HOLE

	THREAD SIZE	PITCH TPI	ORDERING CODE	L	L1	D1	D2	NO. OF FLUTES
1	1/16"	28	TMGB06059L11 28BSPT	57	11.3	6	5.9	3
2	1/8"	28	TMGB08079L14 28BSPT	63	14.0	8	7.9	3
3	1/4"-3/8"	19	TMGB10099L16 19BSPT	73	16.6	10	9.9	4
4	1/2"-7/8"	14	TMGB12119L22 14BSPT	84	22.7	12	11.9	4
5	1"-2"	11	TMGB16159L32 11BSPT	105	32.1	16	15.9	4
6	1"-6"	11	TMGB20199L40 11BSPT	105	40.4	20	19.9	5

PARTIAL PROFILE 60°

INTERNAL / EXTERNAL

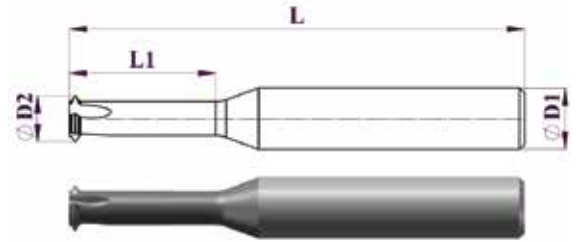
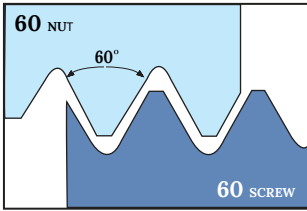

HELICAL FLUTES

	PITCH RANGE		ORDERING CODE	L	L1	D1	D2	NO. OF FLUTES	MIN. HOLE DIAMETER
	MM	TPI							
1	0.35-0.6	72-40	TMP03019L6 P60	39	6	3	1.95	3	2.0
2	0.5-0.8	48-32	TMP03024L7 P60	39	7.7	3	2.45	3	2.6
3	0.5-0.8	48-32	TMP04031L10 P60	51	10	4	3.15	3	3.3
4	0.5-1.0	48-24	TMP0404L12 P60	51	12	4	4.0	3	4.2
5	0.5-1.25	48-20	TMP06047L15 P60	57	15	6	4.7	3	4.9
6	0.5-1.25	48-20	TMP06060L18 P60	57	18	6	6.0	3	6.3
7	0.75-1.5	32-16	TMP0808L24 P60	63	24	8	8.0	3	8.3
8	1.0-2.5	24-10	TMP10100L30 P60	73	30	10	10.0	4	10.4
9	1.0-2.5	24-10	TMP12120L36 P60	84	36	12	12.0	4	12.5

SAME TOOL CAN BE USED FOR THE FOLLOWING OPERATIONS :

- ✓ THREAD MILLING OF EXTERNAL OR INTERNAL THREAD
- ✓ THREAD MILLING OF ISO AND UN STANDARDS
- ✓ CHAMFERING, BACK CHAMFERING, DEBURRING
- ✓ MILLING OF "V" GROOVES

ISO METRIC INTERNAL

ISO 965-1:1999-11
DIN13: 2005-08

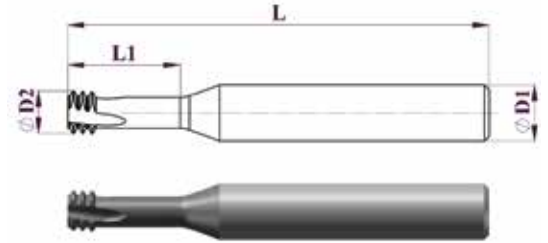
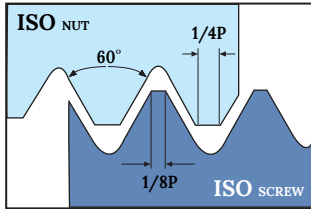

D = NOMINAL THREAD SIZE

THREAD LENGTH - UP TO 2D

	THREAD SIZE	PITCH MM	ORDERING CODE	L	L1	D1	D2	NO. OF FLUTES
1	M1.6x0.35	0.35	TMC03012L3 0.35ISO	39	3.3	3	1.20	3
2	M1.6x0.35	0.35	TMC06012L3 0.35ISO	57	3.3	6	1.20	3
3	M2.0x0.4	0.4	TMC03015L4 0.4ISO	39	4.4	3	1.54	3
4	M2.0x0.4	0.4	TMC06015L4 0.4ISO	57	4.4	6	1.54	3
5	M2.2x0.45	0.45	TMC03016L4 0.45ISO	39	4.8	3	1.63	3
6	M2.5x0.45	0.45	TMC06019L5 0.45ISO	57	5.3	6	1.96	3
7	M3.0x0.5	0.5	TMC06024L6 0.5ISO	57	6.4	6	2.40	3
8	M3.5x0.6	0.6	TMC06027L7 0.6ISO	57	7.4	6	2.75	3
9	M4.0x0.7	0.7	TMC06031L8 0.7ISO	57	8.6	6	3.15	3
10	M5.0x0.8	0.8	TMC06040L12 0.8ISO	57	12.0	6	4.00	3
11	M6.0x1.0	1.0	TMC06047L13 1.0ISO	57	13.0	6	4.75	3
12	M8.0x1.25	1.25	TMC06059L17 1.25ISO	57	17.3	6	5.95	3
13	M10.0x1.5	1.5	TMC08079L22 1.5ISO	63	22.0	8	7.90	3
14	M12.0x1.75	1.75	TMC10094L25 1.75ISO	73	25.5	10	9.40	3
15	M14x2.0	2.0	TMC10099L29 2.0ISO	73	29.0	10	9.95	3
16	M16x2.0	2.0	TMC12119L32 2.0ISO	84	33.0	12	11.95	4
17	M20X2.5	2.5	TMC16159L42 2.5ISO	105	42.0	16	15.90	5

ISO 965-1:1999-11
DIN13: 2005-08

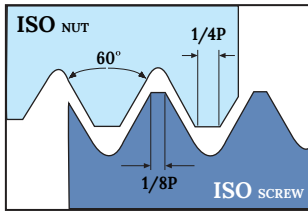

ISO METRIC

INTERNAL

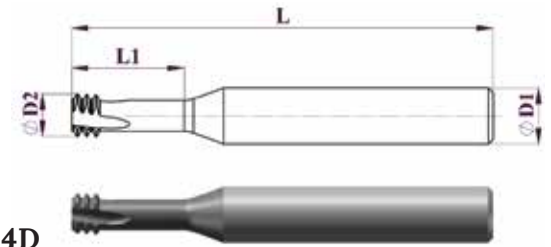

THREAD LENGTH - 3D UP TO 4D

	THREAD SIZE	PITCH MM	ORDERING CODE	L	L1	D1	D2	NO. OF FLUTES
1	M0.8x0.2	0.2	TMC03006L1 0.2ISO	39	1.8	3	0.60	3
2	M1.0x0.25	0.25	TMC03007L3 0.25ISO	39	2.9	3	0.72	3
3	M1.2x0.25	0.25	TMC03009L3 0.25ISO	39	3.0	3	0.90	3
4	M1.4x0.3	0.3	TMC03010L3 0.3ISO	39	3.9	3	1.06	3
5	M1.6x0.35	0.35	TMC03012L5 0.35ISO	39	5.1	3	1.20	3
6	M1.6x0.35	0.35	TMC06012L5 0.35ISO	57	5.1	6	1.20	3
7	M2.0x0.4	0.4	TMC03015L6 0.4ISO	39	6.1	3	1.54	3
8	M2.0x0.4	0.4	TMC03015L10 0.4ISO	39	10.0	3	1.54	3
9	M2.0x0.4	0.4	TMC06015L6 0.4ISO	57	6.1	6	1.54	3
10	M2.0x0.4	0.4	TMCL06015L6 0.4ISO	100	6.1	6	1.54	3
11	M2.5x0.45	0.45	TMC06019L7 0.45ISO	39	7.6	6	1.96	3
12	M2.5x0.45	0.45	TMCL06019L7 0.45ISO	100	7.6	6	1.96	3
13	M3.0x0.5	0.5	TMC06024L9 0.5ISO	57	9.3	6	2.40	3
14	M3.0x0.5	0.5	TMCL06024L9 0.5ISO	100	9.3	6	2.40	3
15	M3.5x0.6	0.6	TMC06027L10 0.6ISO	57	10.6	6	2.75	3
16	M4.0x0.7	0.7	TMC06031L12 0.7ISO	57	12.4	6	3.15	3
17	M4.0x0.7	0.7	TMC06031L16 0.7ISO	57	16.0	6	3.15	3
18	M4.0x0.7	0.7	TMCL06031L12 0.7ISO	100	12.4	6	3.15	3
19	M5.0x0.8	0.8	TMC06040L15 0.8ISO	57	15.6	6	4.00	3
20	M5.0x0.8	0.8	TMC06040L21 0.8ISO	57	21.0	6	4.00	3
21	M5.0x0.8	0.8	TMCL06040L15 0.8ISO	100	15.6	6	4.00	3
22	M6.0x1.0	1.0	TMC06047L19 1.0ISO	57	19.0	6	4.75	3
23	M6.0x1.0	1.0	TMCL06047L19 1.0ISO	100	19.0	6	4.75	3
24	M6.0x1.0	1.0	TMC06047L24 1.0ISO	57	24.0	6	4.75	3
25	M8.0x1.25	1.25	TMC06059L24 1.25ISO	57	24.3	6	5.95	3
26	M8.0x1.25	1.25	TMCL06059L24 1.25ISO	100	24.3	6	5.95	3
27	M10x1.5	1.5	TMC08079L31 1.5ISO	63	31.0	8	7.90	3
28	M10x1.5	1.5	TMCL08079L31 1.5ISO	100	31.0	8	7.90	3
29	M12.0x1.75	1.75	TMC10094L36 1.75ISO	73	36.0	10	9.40	3
30	M16x2.0	2.0	TMCL12119L48 2.0ISO	100	48.0	12	11.95	4

UN INTERNAL

ANSI B1.1 - 1982

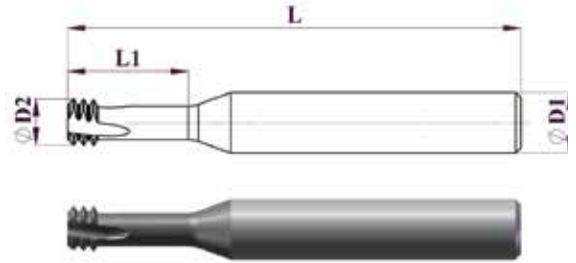
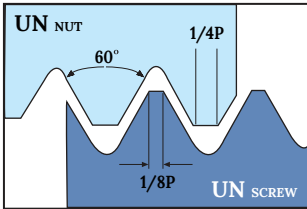

THREAD LENGTH - UP TO 2D

D = NOMINAL THREAD SIZE

	THREAD SIZE		PITCH TPI	ORDERING CODE	L	L1	D1	D2	NO. OF FLUTES
	COARSE UNC	FINE UNF							
1		1-72	72	TMC03014L3 72UN	39	3.8	3	1.44	3
2	1-64	2-64	64	TMC03014L3 64UN	39	3.9	3	1.40	3
3	2-56	3-56	56	TMC03016L4 56UN	39	4.6	3	1.66	3
4	2-56	3-56	56	TMC06016L4 56UN	57	4.6	6	1.66	3
5	3-48	4-48	48	TMC06018L5 48UN	57	5.4	6	1.88	3
6	4-40		40	TMC06021L6 40UN	57	6.2	6	2.12	3
7	5-40	6-40	40	TMC06024L7 40UN	57	7.1	6	2.46	3
8		8-36	36	TMC06033L8 36UN	57	8.8	6	3.31	3
9	6-32		32	TMC06025L7 32UN	57	7.3	6	2.57	3
10	8-32		32	TMC06032L10 32UN	57	10.1	6	3.22	3
11		10-32	32	TMC06037L10 32UN	57	10.5	6	3.70	3
12		12-28	28	TMC06042L10 28UN	57	10.9	6	4.20	3
13		1/4"-28	28	TMC06052L14 28UN	57	14.0	6	5.20	3
14	10-24		24	TMC06035L10 24UN	57	10.4	6	3.55	3
15		5/16"-24	24	TMC08066L16 24UN	63	16.7	8	6.65	3
16	1/4"-20	7/16"-20	20	TMC06048L13 20UN	57	13.7	6	4.85	3
17		7/16"-20	20	TMC08079L24 20UN	63	24.0	8	7.95	3
18	5/16"-18		18	TMC06059L16 18UN	57	16.5	6	5.95	3
19		5/8"-18	18	TMC12119L34 18UN	84	34.0	12	11.90	4
20	3/8"-16		16	TMC08069L21 16UN	63	21.0	8	6.90	3
21	7/16"-14		14	TMC08079L23 14UN	63	23.5	8	7.95	3
22	1/2"-13		13	TMC10093L27 13UN	73	27.0	10	9.30	3
23	9/16"-12		12	TMC10099L29 12UN	63	29.0	10	9.95	3
24	5/8"-11		11	TMC12115L33 11UN	84	33.0	12	11.50	3

UN INTERNAL

ANSI B1.1 - 1982

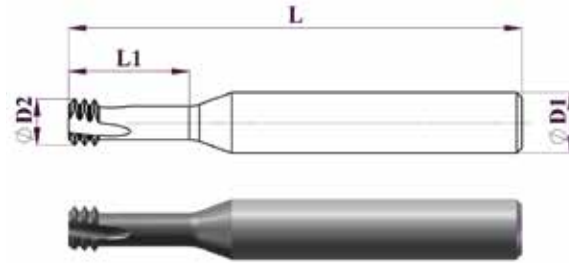
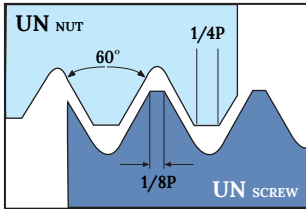

THREAD LENGTH - UP TO 3D

D = NOMINAL THREAD SIZE

	THREAD SIZE		PITCH TPI	ORDERING CODE	L	L1	D1	D2	NO. OF FLUTES
	COARSE UNC	FINE UNF							
1		0-80	80	TMC03011L3 80UN	39	3.9	3	1.18	3
2		1-72	72	TMC03014L5 72UN	39	5.8	3	1.44	3
3		1-72	72	TMC06014L5 72UN	57	5.8	6	1.44	3
4	2-56	3-56	56	TMC03016L6 56UN	39	6.8	3	1.66	3
5	2-56	3-56	56	TMC06016L6 56UN	57	6.8	6	1.66	3
6	2-56	3-56	56	TMCL06016L6 56UN	100	6.8	6	1.66	3
7	4-40		40	TMC06021L8 40UN	57	8.1	6	2.12	3
8	4-40		40	TMCL06021L8 40UN	100	8.1	6	2.12	3
9	5-40		40	TMC06024L9 40UN	57	9.8	6	2.46	3
10	6-32	6-40	32	TMC06025L10 32UN	57	10.7	6	2.57	3
11	6-32		32	TMCL06025L10 32UN	100	10.7	6	2.57	3
12	8-32		32	TMC06032L12 32UN	57	12.7	6	3.22	3
13		10-32	32	TMC06037L15 32UN	57	15.5	6	3.70	3
14		10-32	32	TMCL06037L15 32UN	100	15.5	6	3.70	3
15		12-28	28	TMC06042L16 28UN	57	16.0	6	4.20	3
16		1/4"-28	28	TMC06052L19 28UN	57	19.3	6	5.20	3
17		1/4"-28	28	TMCL06052L19 28UN	100	19.3	6	5.20	3
18		5/16"-24	24	TMC08066L24 24UN	63	24.2	8	6.65	3
19	1/4"-20	7/16"-20	20	TMC06048L19 20UN	57	19.4	6	4.85	3
20	1/4"-20	7/16"-20	20	TMCL06048L19 20UN	100	19.4	6	4.85	3
21	5/16"-18		18	TMC06059L23 18UN	57	23.0	6	5.90	3
22	3/8"-16		16	TMC08069L28 16UN	63	28.5	8	6.90	3

UNJ INTERNAL

MIL-S-8879A

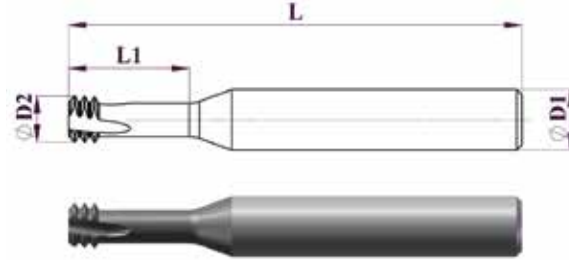
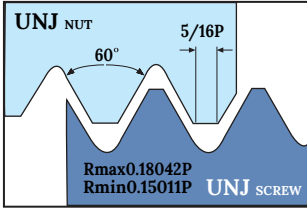

D = NOMINAL THREAD SIZE

THREAD LENGTH - UP TO 3D

	THREAD SIZE		PITCH TPI	ORDERING CODE	L	L1	D1	D2	NO. OF FLUTES
	COARSE UNJC	FINE UNJF							
1	4	6	40	TMC06021L8 40UNJ	57	8.0	6	2.10	3
2	8	10	32	TMC06033L12 32UNJ	57	12.0	6	3.30	3
3		1/4"	28	TMC06054L19 28UNJ	57	19.0	6	5.40	3
4		5/16" , 3/8"	24	TMC08067L24 24UNJ	63	24.0	8	6.70	3
5	1/4"		20	TMC06050L19 20UNJ	63	19.0	6	5.00	3
6		7/16"	20	TMC08079L28 20UNJ	63	28.0	8	7.90	3
7	5/16"		18	TMC08064L24 18UNJ	63	24.0	8	6.40	3
8	3/8"		16	TMC08069L24 16UNJ	63	24.0	8	6.90	3
9	7/16"		14	TMC08079L26 14UNJ	63	26.0	8	7.90	3
10	1/2"		13	TMC10099L28 13UNJ	73	28.0	10	9.90	3

ISO 5855-1:1989

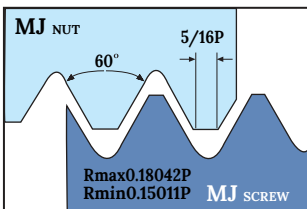

MJ INTERNAL

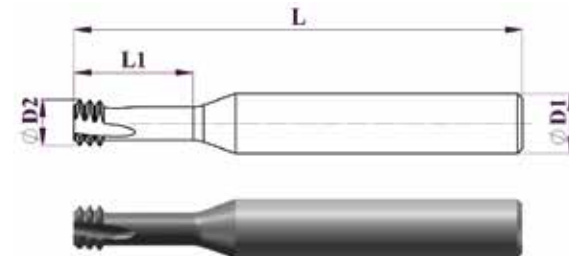

	THREAD SIZE	PITCH MM	ORDERING CODE	L	L1	D1	D2	NO. OF FLUTES
1	MJ4.0	0.7	TMC06032L12 0.7MJ	57	12.0	6	3.20	3
2	MJ5.0	0.8	TMC06040L15 0.8MJ	57	15.0	6	4.00	3
3	MJ6.0	1.0	TMC06048L18 1.0MJ	57	18.0	6	4.80	3
4	MJ8.0	1.25	TMC08065L24 1.25MJ	63	24.0	8	6.50	3
5	MJ10.0	1.5	TMC08079L31 1.5MJ	63	31.0	8	7.90	3
6	MJ12.0	1.75	TMC10094L31 1.75MJ	73	31.0	10	9.40	3
7	MJ14.0 , MJ16.0	2.0	TMC10099L36 2.0MJ	73	36.0	10	9.90	3

MINIATURE TOOLS FOR HARD MATERIAL - UP TO 62 HRC

ISO METRIC INTERNAL

ISO 965-1:1999-11
DIN13 2005-08

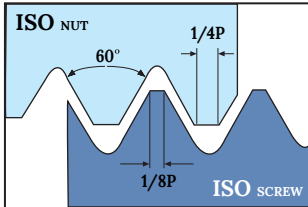

LEFT HAND CUTTING, CNC CODE: M04

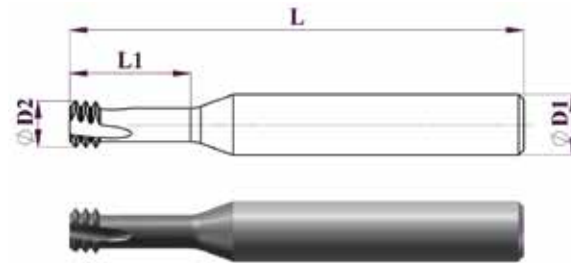

THREAD LENGTH - UP TO 2D

D = NOMINAL THREAD SIZE

	THREAD SIZE	PITCH MM	ORDERING CODE	L	L1	D1	D2	NO. OF FLUTES
1	M1.6x0.35	0.35	TMD06012L3 0.35ISO	57	3.3	6	1.20	3
2	M2.0x0.4	0.4	TMD06015L4 0.4ISO	57	4.4	6	1.54	3
3	M2.2x0.45	0.45	TMD06016L4 0.45ISO	57	4.8	6	1.63	3
4	M2.5x0.45	0.45	TMD06019L5 0.45ISO	57	5.3	6	1.96	3
5	M3.0x0.5	0.5	TMD06024L6 0.5ISO	57	6.4	6	2.40	3
6	M3.5x0.6	0.6	TMD06027L7 0.6ISO	57	7.4	6	2.75	3
7	M4.0x0.7	0.7	TMD06031L8 0.7ISO	57	8.6	6	3.15	3
8	M5.0x0.8	0.8	TMD06040L12 0.8ISO	57	12.0	6	4.0	3
9	M6.0x1.0	1.0	TMD06047L13 1.0ISO	57	13.0	6	4.75	3
10	M8.0x1.25	1.25	TMD06059L17 1.25ISO	57	17.3	6	5.95	3
11	M10.0x1.5	1.5	TMD08079L22 1.5ISO	63	22.0	8	7.90	3

THREAD LENGTH - UP TO 3D

	THREAD SIZE	PITCH MM	ORDERING CODE	L	L1	D1	D2	NO. OF FLUTES
1	M1.6x0.35	0.35	TMD06012L5 0.35ISO	57	5.1	6	1.20	3
2	M2.0x0.4	0.4	TMD06015L6 0.4ISO	57	6.1	6	1.54	3
3	M2.5x0.45	0.45	TMD06019L7 0.45ISO	57	7.6	6	1.96	3
4	M3.0x0.5	0.5	TMD06024L9 0.5ISO	57	9.3	6	2.40	3
5	M4.0x0.7	0.7	TMD06031L12 0.7ISO	57	12.4	6	3.15	3
6	M5.0x0.8	0.8	TMD06040L15 0.8ISO	57	15.6	6	4.00	3
7	M6.0x1.0	1.0	TMD06047L19 1.0ISO	57	19.0	6	4.75	3
8	M8.0x1.25	1.25	TMD06059L24 1.25ISO	57	24.3	6	5.95	3

MINIATURE TOOLS FOR HARD MATERIAL - UP TO 62 HRC

UN INTERNAL

ANSI B1.1-1982

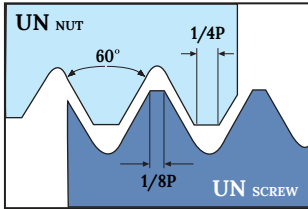

LEFT HAND CUTTING, CNC CODE: M04

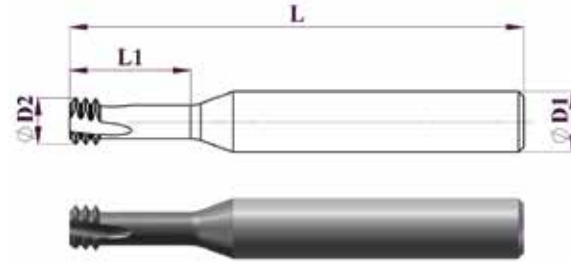

D = NOMINAL THREAD SIZE

THREAD LENGTH - UP TO 2D

	THREAD SIZE		PITCH TPI	ORDERING CODE	L	L1	D1	D2	NO. OF FLUTES
	COARSE UNC	FINE UNF							
1		1-72	72	TMD06014L3 72UN	57	3.8	6	1.44	3
2	1-64	2-64	64	TMD06014L3 64UN	57	3.9	6	1.40	3
3	2-56	3-56	56	TMD06016L4 56UN	57	4.6	6	1.66	3
4	3-48	4-48	48	TMD06018L5 48UN	57	5.4	6	1.88	3
5	4-40		40	TMD06021L6 40UN	57	6.2	6	2.12	3
6	5-40	6-40	40	TMD06024L7 40UN	57	7.1	6	2.46	3
7		8-36	36	TMD06033L8 36UN	57	8.8	6	3.31	3
8	6-32		32	TMD06025L7 32UN	57	7.8	6	2.57	3
9	8-32	10-32	32	TMD06032L10 32UN	57	10.3	6	3.22	3
10		1/4"-28	28	TMD06052L14 28UN	57	14.0	6	5.20	3
11	10-24		24	TMD06035L10 24UN	57	10.4	6	3.55	3
12		5/16"-24	24	TMD08066L16 24UN	64	16.7	8	6.65	3
13	1/4"-20	7/16"-20	20	TMD06048L13 20UN	57	13.7	6	4.85	3
14		7/16"-20	20	TMD08079L24 20UN	64	24.0	8	7.95	3
15	5/16"		18	TMD06059L16 18UN	57	16.5	6	5.95	3
16	3/8"		16	TMD08069L20 16UN	63	20.0	8	6.90	3
17	7/16"-14		14	TMD08079L23 14UN	63	23.5	8	7.95	3

THREAD LENGTH - UP TO 3D

	THREAD SIZE		PITCH TPI	ORDERING CODE	L	L1	D1	D2	NO. OF FLUTES
	COARSE UNC	FINE UNF							
1		1-72	72	TMD06014L5 72UN	57	5.8	6	1.44	3
2	5-40	6-40	40	TMD06024L9 40UN	57	9.8	6	2.46	3
3	8-32	10-32	32	TMD06032L12 32UN	57	12.7	6	3.22	3
4		1/4"-28	28	TMD06052L19 28UN	57	19.3	6	5.20	3
5		5/16"-24	24	TMD08066L24 24UN	63	24.2	8	6.65	3
6	1/4"-20	7/16"-20	20	TMD06048L19 20UN	57	19.4	6	4.85	3

ISO METRIC INTERNAL

ISO 965-1:1999-11
 DIN13 2005-08

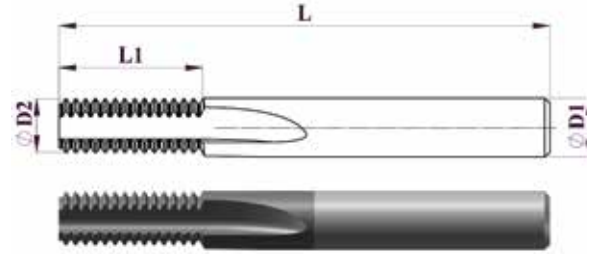
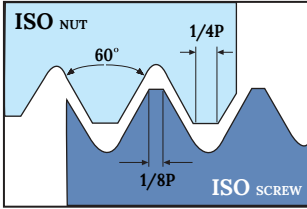

STRAIGHT FLUTES

	THREAD SIZE		PITCH MM	ORDERING CODE	L	L1	D1	D2	NO. OF FLUTES
	COARSE	FINE							
1		M8.0X0.75	0.75	TMX06059L10 0.75ISO	57	10.8	6	5.9	3
2	M5.0x0.8		0.8	TMX06039L10 0.8ISO	57	10.0	6	3.9	3
3	M6.0x1.0	M7.0x1.0	1.0	TMX06048L11 1.0ISO	57	11.5	6	4.8	3
4		M10.0x1.0	1.0	TMX08079L17 1.0ISO	63	17.5	8	7.9	4
5		M12x1.0	1.0	TMX10099L20 1.0ISO	73	20.5	10	9.9	4
6	M8.0x1.25	M9.0x1.25	1.25	TMX06059L14 1.25ISO	57	14.4	6	5.9	3
7	M10x1.5	M11.0x1.5	1.5	TMX08079L18 1.5ISO	63	18.5	8	7.9	3
8		M13.0x1.5	1.5	TMX10099L21 1.5ISO	73	21.8	10	9.9	4
9		M15.0x1.5	1.5	TMX12119L26 1.5ISO	84	26.3	12	11.9	4
10	M12.0x1.75		1.75	TMX08079L18 1.75ISO	64	18.0	8	7.9	3
11	M14.0x2.0		2.0	TMX10099L25 2.0ISO	73	25.0	10	9.9	3
12	M16.0x2.0		2.0	TMX12119L27 2.0ISO	84	27.0	12	11.9	4
13	M20.0x2.5		2.5	TMX12119L30 2.5ISO	84	30.0	12	11.9	4
14	M24.0x3.0	M27.0x3.0	3.0	TMX16159L40 3.0ISO	105	40.5	16	15.9	4

UN (UNC, UNF, UNEF) INTERNAL

ANSI B1.1-1982

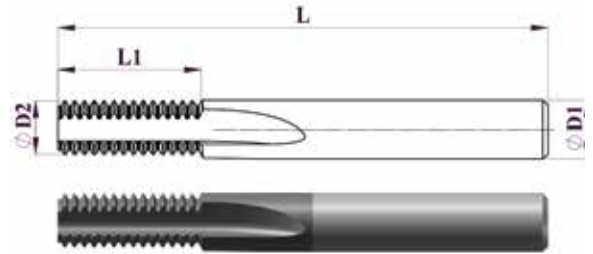
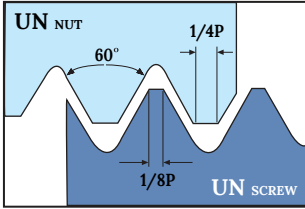

STRAIGHT FLUTES

	THREAD SIZE			PITCH TPI	ORDERING CODE	L	L1	D1	D2	NO. OF FLUTES
	COARSE UNC	FINE UNF	EXTRA FINE UNEF							
1		1/4"	5/16"	32	TMX06059L14 32UN	57	14.0	6	5.9	3
2				28	TMX06051L12 28UN	57	12.2	6	5.1	3
3		5/16"	7/16"-1/2"	28	TMX08079L15 28UN	63	15.8	8	7.9	4
4	1/4"			24	TMX06059L10 24UN	57	10.8	6	5.9	3
5		7/16"		20	TMX06048L12 20UN	57	12.0	6	4.8	3
6		1/2"		20	TMX08079L19 20UN	63	19.7	8	7.9	3
7	5/16"			20	TMX10099L17 20UN	73	17.5	10	9.9	4
8		9/16"-5/8"		18	TMX06057L16 18UN	57	16.0	6	5.7	3
9	3/8"			18	TMX08079L18 18UN	63	18.5	8	7.9	3
10		3/4"		16	TMX08068L18 16UN	63	18.2	8	6.8	3
11	7/16"			16	TMX12119L26 16UN	84	26.2	12	11.9	4
12		7/8"		14	TMX08078L20 14UN	63	20.8	8	7.8	3
13	1/2"			14	TMX12119L24 14UN	84	24.5	12	11.9	4
14	9/16"			13	TMX10093L24 13UN	73	24.4	10	9.3	3
15		1		12	TMX12119L27 12UN	84	26.4	12	10.6	4
16	5/8"			12	TMX16159L39 12UN	105	39.1	16	15.9	5
17	3/4"			11	TMX12115L31 11UN	84	31.1	12	11.5	4
18	7/8"			10	TMX16143L36 10UN	105	36.8	16	14.3	4
19	1			9	TMX16159L40 9UN	105	40.9	16	15.9	4
20				8	TMX20197L39 8UN	105	39.7	20	19.7	4

NPT INTERNAL / EXTERNAL

ANSI/ASME B 1.20.1-1983

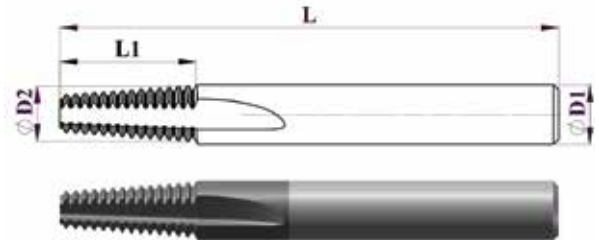
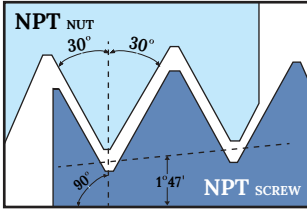

STRAIGHT FLUTES

	THREAD SIZE	PITCH TPI	ORDERING CODE	L	L1	D1	D2	NO. OF FLUTES
1	1/16"-1/8"	27	TMX06059L09 27NPT	57	9.8	6	5.9	3
2	1/4"-3/8"	18	TMX10099L16 18NPT	73	16.2	10	9.9	4
3	1/2"	14	TMX12119L20 14NPT	83	20.8	12	11.9	4
4	1"-2"	11.5	TMX20199L29 11.5NPT	105	29.7	20	19.9	4
5	2 1/2"-6"	8	TMX20199L38 8NPT	105	38.1	20	19.9	4

NPTF INTERNAL / EXTERNAL

ANSI B 1.20.3-1976

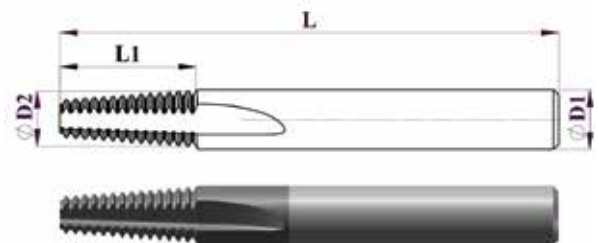
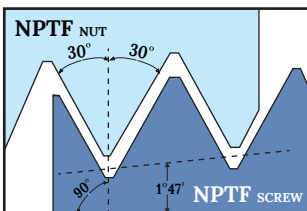

STRAIGHT FLUTES

	THREAD SIZE	PITCH TPI	ORDERING CODE	L	L1	D1	D2	NO. OF FLUTES
1	1/16"-1/8"	27	TMX06059L09 27NPTF	57	9.9	6	5.9	3
2	1/4"-3/8"	18	TMX10099L16 18NPTF	73	16.2	10	9.9	4
3	1/2"	14	TMX12119L20 14NPTF	83	20.8	12	11.9	4
4	1"-2"	11.5	TMX20199L29 11.5NPTF	105	29.7	20	19.9	4
5	2 1/2"-6"	8	TMX20199L38 8NPTF	105	38.1	20	19.9	4

BSP (G)

INTERNAL / EXTERNAL

B.S.84: 1956
ISO 228 - 1: 1994

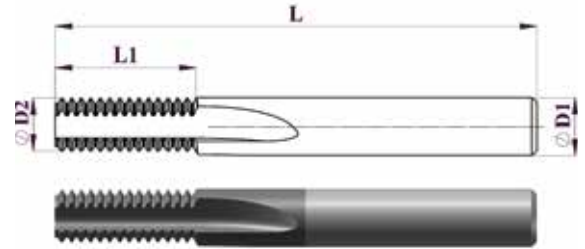
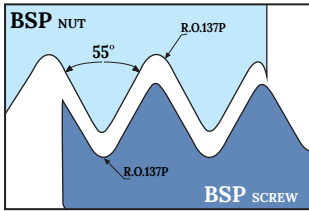

STRAIGHT FLUTES

	THREAD SIZE	PITCH TPI	ORDERING CODE	L	L1	D1	D2	NO. OF FLUTES
1	1/16"-1/8"	28	TMX06059L11 28BSP	57	11.3	6	5.9	3
2	1/4"-3/8"	19	TMX10099L16 19BSP	73	16.6	10	9.9	4
3	1/2"-7/8"	14	TMX12119L22 14BSP	83	22.7	12	11.9	4
4	1"-2"	11	TMX16159L32 11BSP	105	32.1	16	15.9	4

BSPT (Rc)

INTERNAL / EXTERNAL

B.S.21: 1985

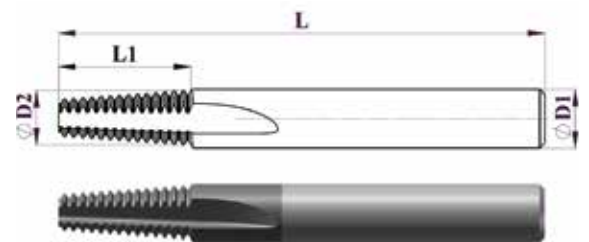
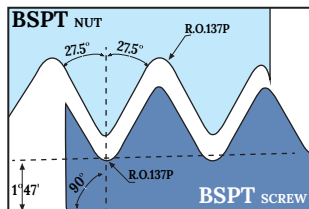

STRAIGHT FLUTES

	THREAD SIZE	PITCH TPI	ORDERING CODE	L	L1	D1	D2	NO. OF FLUTES
1	1/16"-1/8"	28	TMX06059L11 28BSPT	57	11.3	6	5.9	3
2	1/4"-3/8"	19	TMX10099L16 19BSPT	73	16.6	10	9.9	4
3	1/2"-7/8"	14	TMX12119L22 14BSPT	83	22.7	12	11.9	4
4	1"-2"	11	TMX16159L32 11BSPT	105	32.1	16	15.9	4

CHAMFERS TOOLS

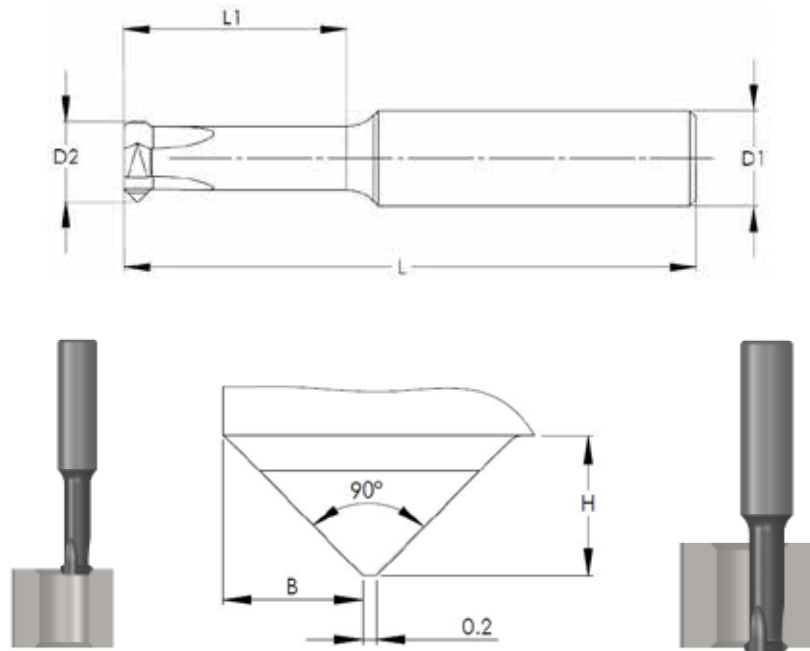

L1-SHORT

	ORDERING CODE	D1	D2	L1	H	B	α	NO. OF FLUTES	L
1	CMP03015L4 P90	3	1.5	4	0.3	0.4	90°	3	39
2	CMP03020L5 P90	3	2.0	5	0.4	0.5	90°	3	39
3	CMP03025L6 P90	3	2.5	6	0.5	0.6	90°	3	39
4	CMP04031L8 P90	4	3.1	8	0.6	0.6	90°	3	51
5	CMP04039L10 P90	4	3.9	10	0.8	0.9	90°	3	51
6	CMP06045L11 P90	6	4.5	11	1.1	1.2	90°	3	58
7	CMP06049L12 P90	6	4.9	12	1.1	1.2	90°	3	58
8	CMP06059L14 P90	6	5.9	14	1.5	1.6	90°	3	58
9	CMP08079L20 P90	8	7.9	20	1.6	1.7	90°	3	64

L1-LONG

	ORDERING CODE	D1	D2	L1	H	B	α	NO. OF FLUTES	L
1	CMP04031L12 P90	4	3.1	12	0.6	0.6	90°	3	51
2	CMP04039L16 P90	4	3.9	16	0.8	0.9	90°	3	51
3	CMP06049L20 P90	6	4.9	20	1.1	1.2	90°	3	58
4	CMP06059L24 P90	6	5.9	24	1.5	1.6	90°	3	58
5	CMP08079L30 P90	8	7.9	30	1.6	1.7	90°	3	64

TAPER END MILL & 45° CHAMFER (BSPT, NPT, NPTF)

INTERNAL / EXTERNAL

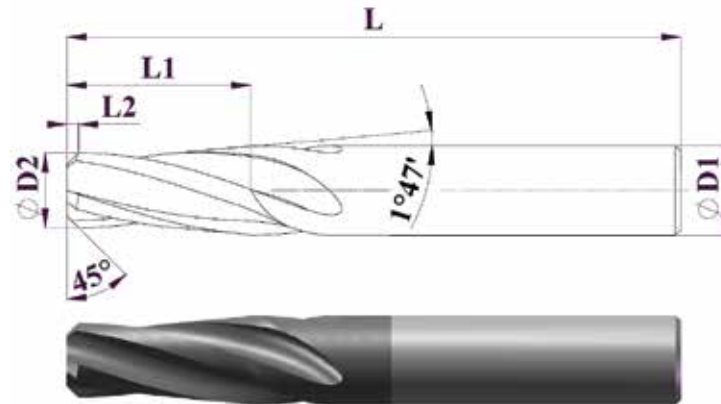

	ORDERING CODE	D1	D2	L	L1	L2	NO. OF FLUTES
1	PM0605L15	6	5	58	15	1.0	4
2	PM1084L25	10	8.4	73	25	1.4	4
3	PM1299L33	12	9.9	84	33	1.8	4

SAME TOOL CAN BE USED FOR THE FOLLOWING OPERATIONS:

- ✓ CONIC MILLING PREPARATION FOR CONIC THREADS (EXTERNAL & INTERNAL)
- ✓ CHAMFERING

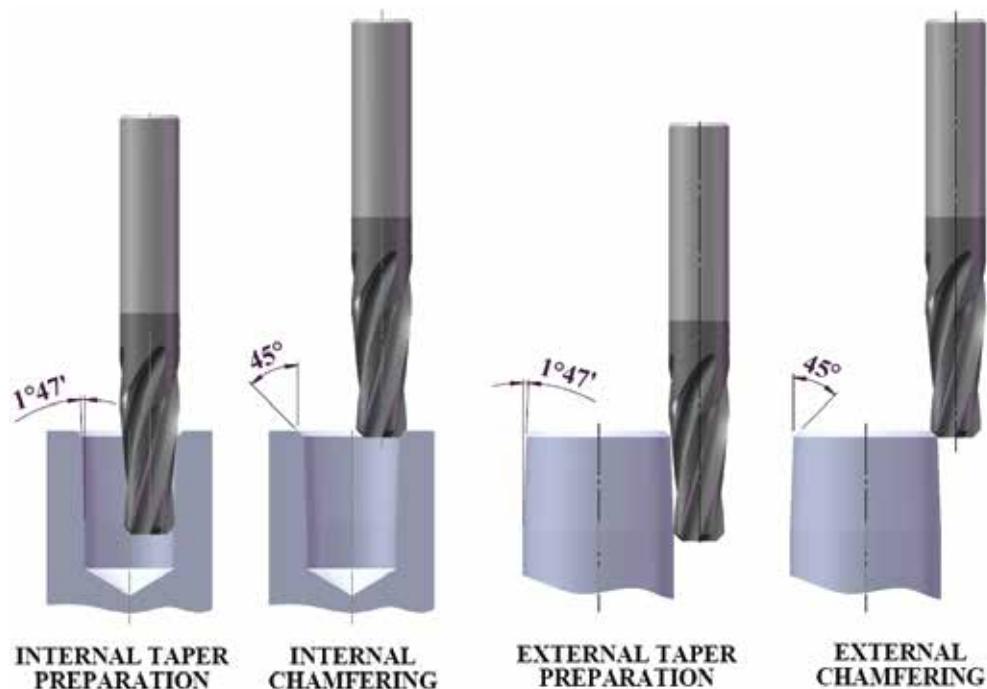

TECHNICAL SECTION

THREAD MILLING CYCLE (TMC, TMD TYPES)

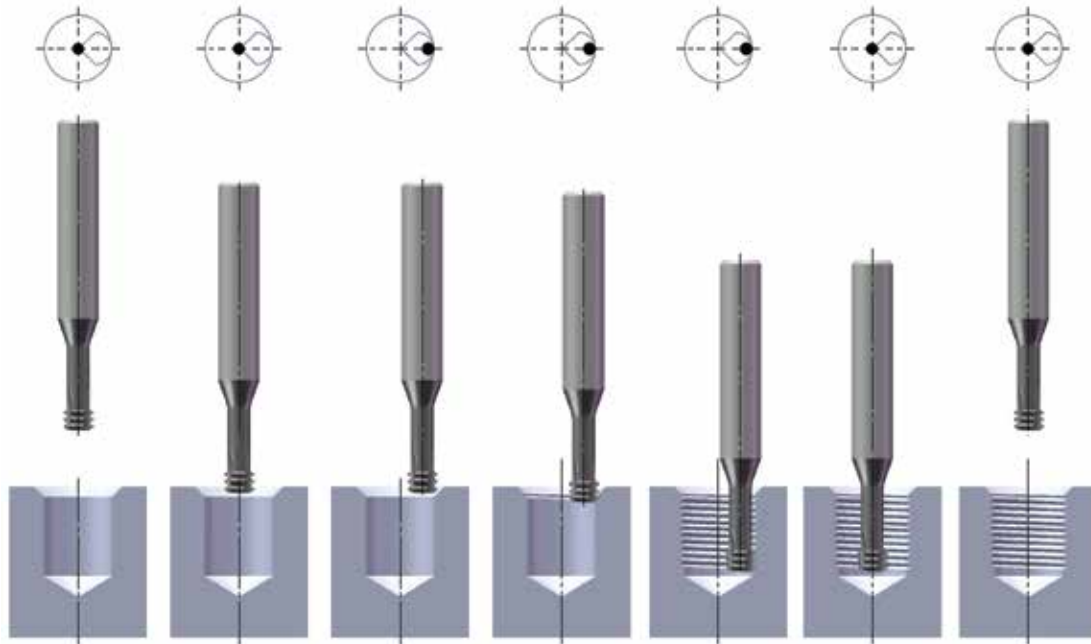

THREAD MILLING CYCLE (TMG, TMX TYPES)

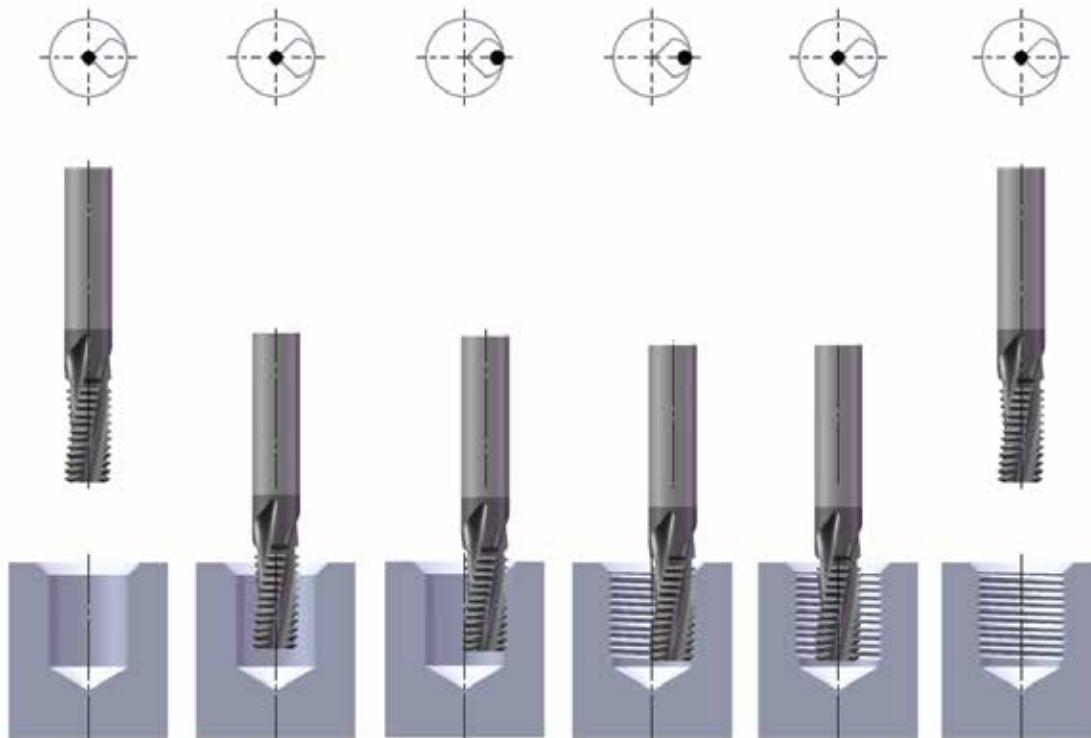

TECHNICAL SECTION

MACHINING CONDITIONS

CARBIDE GRADE : K520C

AN ADVANCED PVD TiAlN COATED GRADE OVER A TOUGH WEAR-RESISTANT SUBMICRON SUBSTRATE FOR GENERAL PURPOSE MACHINING OF STEEL, STAINLESS STEEL, SUPERALLOYS.

ISO	MATERIAL	HARDNESS HB	CUTTING SPEED M/MIN	FEED MM/TOOTH CUTTING DIAMETERS						
				1.5-3	3-5	5-7	7-9	9-11	11-14	14-20
P	NON-ALLOY STEEL FREE MACHINING STEEL	130	70-130	0.03	0.04	0.06	0.07	0.09	0.09	0.12
	LOW CARBON ALLOY STEEL	200	60-120	0.02	0.04	0.05	0.06	0.08	0.08	0.10
	HIGH CARBON ALLOY STEEL	240	60-110	0.02	0.03	0.04	0.05	0.05	0.05	0.08
	TOOL STEEL CAST STEEL	270	60-100	0.02	0.03	0.04	0.05	0.05	0.05	0.06
	HEAT TREATED STEEL	400	50-80	0.01	0.02	0.03	0.03	0.04	0.04	0.05
M	300 STAINLESS STEEL: (303,304,316)	200	70-100	0.02	0.02	0.03	0.04	0.05	0.05	0.07
	400 STAINLESS STEEL: (420, 440)	240	70-90	0.02	0.02	0.03	0.04	0.04	0.04	0.06
	17-4 PH, 15-5 PH, 13-8MO PH	400	60-80	0.015	0.02	0.02	0.03	0.03	0.03	0.04
K	GREY CAST IRON	190	60-110	0.02	0.03	0.06	0.07	0.08	0.09	0.11
	NODULAR CAST IRON	180	60-90	0.02	0.03	0.05	0.06	0.08	0.09	0.12
	MALLEABLE CAST IRON	240	60-90	0.02	0.02	0.03	0.05	0.07	0.08	0.11
N	WROUGHT ALUMINUM: (2024, 6061, 7075...)	80	80-300	0.03	0.04	0.06	0.07	0.10	0.13	0.15
	CAST ALUMINUM	90	100-300	0.03	0.04	0.06	0.07	0.11	0.13	0.16
	COPPER ALLOYS: BRASS, BRONZE, COPPER SILICON	100	60-250	0.03	0.04	0.06	0.07	0.11	0.13	0.16
	NON METALIC: Rubber, Polypropylene, Thermoplastics (PVC), Thermosetting Plastics (FIBERGLASS), Polyamides,		100-400	0.05	0.06	0.08	0.09	0.13	0.15	0.18
S	TITANIUM :									
	PURE TITANIUM: 99.0Ti		40-80	0.02	0.02	0.02	0.03	0.04	0.04	0.05
	ALPHA ALLOYS:Ti 5Al2.5Sn		30-60	0.02	0.02	0.02	0.03	0.03	0.04	0.05
	BETA ALLOYS: Ti 1 3V11Cr3Al		20-50	0.02	0.02	0.02	0.03	0.03	0.03	0.04
	ALPHA-BETA ALLOYS : Ti 6Al4V		20-50	0.02	0.02	0.02	0.02	0.03	0.03	0.04
	COBALT BASE ALLOYS: STELLITE	350	20-40	0.01	0.01	0.01	0.02	0.02	0.03	0.03
	NIKEL BASE ALLOYS: INCONEL, HASTELLOY, WASPALLOY, KOVAR	300	20-40	0.01	0.01	0.01	0.02	0.02	0.03	0.03
HIGH TEMPRERATURE ALLOYS: IRON BASED: INCOLOY	270	25-50	0.01	0.01	0.01	0.02	0.02	0.03	0.03	
H	HARDENED STEEL	56 HRc	25-50	0.01	0.01	0.02	0.02	0.02	0.03	0.03
	HARDENED CAST IRON	50 HRc	25-40	0.01	0.01	0.02	0.02	0.02	0.03	0.03

TROUBLESHOOTING

PROBLEM	CAUSE	SOLUTION
CHIPPING IN CUTTING EDGES	UNSTABLE CONDITIONS	CHECK TOOL AND WORKPIECE CLAMPING AND STABILITY
	FEED RATE TOO HIGH	DECREASE FEED PER TOOTH
	DEPTH OF CUT LARGE	INCREASE THE NUMBER OF THREAD MILLING PASSES
EXCESSIVE WEAR	INCORRECT CUTTING SPEED	DECREASE CUTTING SPEED
	INCORRECT FEED PER TOOTH	INCREASE FEED PER TOOTH
	INSUFFICIENT COOLANT	<ul style="list-style-type: none"> •CHECK STABILITY •INCREASE THE COOLANT FLOW •CHANGE TO CLIMB MILLING
VIBRATIONS	CUTTING SPEED TOO HIGH	CHANGE CUTTING SPEED
	INCORRECT TOOL AND WORKPIECE INSTALLTION	CHECK SABILITY OF WORKPIECE
	LARGE DEPTH OF CUT STABILITY: TOOL/MACHINE, WORKPIECE/WORKPIECE CLAMPING	CHANGE TO NUMBER OF PASSES
	CONCENTRICITY	MAKE SURE TOOL OVERHANG IN THE HOLDING DEVICE AS SHORT AS POSSIBLE
BAD SURFACE FINISH ON WORKPIECE		<ul style="list-style-type: none"> •INCREASE CUTTING SPEED •DECREASE FEED PER TOOTH •CHECK STABILITY AND OVERHANG OF TOOLS
SMALL DIFFERENCE BETWEEN GAUGES (GO/NOT GO)	RATIO TOO CLOSE (TOOL CUTTING DIAMETER / THREAD DIAMETER)	CHOOSE TOOL WITH SMALLER CUTTING DIAMETER



📍 Adom st. 1, Industrial Park Misgav 2017900, P.O. Box 17, Israel
☎ Tel: +972-49990026 📠 Fax: +972-49990027
✉ sales@erojet-tools.com 🌐 www.erojet-tools.com