



enseigne publicitaire

usinage de matières plastiques, composites & métaux légers

signmaking

plastic, composites & lightmetal machining



LMT Technology Group

**BELIN
FETTE
KIENINGER
ONSRUD**

in alliance

**BILZ
BOEHLERIT**

ÉDITION
V8

www.lmt-belin.com

FR LMT Belin fait partie depuis 2001 du Groupe LMT qui regroupe sous une même bannière quatre fabricants d'outils coupants experts dans différents domaines :

- LMT Kieninger, spécialiste dans la fabrication d'outils pour l'industrie des moules et matrices,
- LMT Fette, spécialiste du taillage d'engrenages, des outils de filetage (taroudage, roulage) et d'autres outils de fraisage hautes performances,
- LMT Onsrud, spécialiste dans la fabrication d'outils coupants pour les matériaux réfractaires, plastiques et composites.

Présent tout autour de la planète par le biais de filiales et distributeurs exclusifs, LMT Tools fournisseur des industries de l'usinage est votre partenaire de performance industrielle.

EN LMT Belin is part of the LMT Group since 2001. The group has its roots in Germany and gathers together four cutting tools manufacturers:

- LMT Kieninger, specialist in mold and dies industries and special tools,
- LMT Fette, specialist in gear cutters, threading solutions (taps and rolling systems) and other high performance milling systems,
- LMT Onsrud, specialist in exotic metals, composites and plastics,

Each firm has its own competences and allows LMT Group to supply performing products throughout the whole world thanks to subsidiaries and exclusive partners.

DE LMT Belin ist seit 2001 Teil der LMT Gruppe, zu der vier Hersteller von Schneidwerkzeugen gehören. Jeder dieser Hersteller ist Experte in seinem Sachgebiet.

- LMT Kieninger, Spezialist in der Herstellung von Werkzeugen für die Gesenk-, Formen- und Modellbauindustrie.
- LMT Fette, Spezialist in der Herstellung von Verzahnungsfräsern, Gewinderollsystemen (Gewindebohrern, Gewinderollen) sowie anderer Hochleistungsfräswerkzeuge
- LMT Onsrud, Spezialist in der Herstellung von Schneidwerkzeugen für hitzebeständige Materialien, Kunststoffen und Verbundwerkstoffen.

Rund um die Welt durch exklusive Handelsvertretungen vertreten, liefert LMT Tools als Partner von Industrieleistungen an die Fertigungsindustrie.



LMT Fette DE



LMT Kieninger DE



LMT Onsrud US



LMT Belin FR



FR

Les hommes et femmes de la société LMT Belin France sont sa principale richesse.

Depuis plus de 50 ans, ils détiennent, transmettent et adaptent leur savoir-faire unique dans la conception et la réalisation des outils coupants, pour proposer à ses partenaires les solutions performantes dont ils ont besoin.

EN

Women and men working at LMT Belin France are our main source of wealth

For over 50 years they learn, share and adapt their unique know-how in designing and manufacturing cutting tools. Our goal is to offer performing solutions meeting the highest demands.

DE

Die Mitarbeiter der Firma LMT Belin France sind sein haupsächlicher Reichtum.

Seit über 50 Jahre verfügen und übermitteln wir unser einzigartiges Wissen in der Entwicklung und der Herstellung von Schneidwerkzeugen, um uns an unsere Partner anzupassen und leistungsfähige Lösungen anzubieten.





FR

Innovater, tester et qualifier...

LMT Belin dispose de moyens de tests spécifiques pour développer de nouvelles solutions d'usinage. Carbure monobloc, fraises à plaquettes PCD, fraises de forme, fraises à surfacer, fraises à graver, tous nos produits sont testés afin de vous garantir une qualité maximale.

Cet espace dédié à la recherche et au développement nous permet de mener des tests pour nos clients afin de délivrer des solutions fiables et qui répondent à leurs besoins.

EN

Innovate, test and qualify

LMT Belin is equipped with specific machines to develop new machining solutions. Solid carbide endmills, PCD tipped mills, form cutters, surface cutters, engraving mills, ... We make a point to test every tool developed so that you get the most qualitative tool.

This dedicated area for research and development is also used to run tests for our partners to deliver trustful tools matching their needs.

DE

Neuerungen einführen, testen und qualifizieren...

LMT Belin verfügt über eine 3-achsige Fräsmaschine um neue Fertigungslösungen zu entwickeln. VHM Fräser, mit gelöteten PKD Platten, Formfräser, Fräser zum Planfräsen, Gravierfräser. Alle unsere Produkte werden getestet um eine maximale Qualität zu gewährleisten.

Dieser Freiraum zur Forschung und Entwicklung erlaubt es uns Tests für unsere Partner durchzuführen und somit verlässliche Lösungen zu liefern die Ihren Anforderungen entsprechen.



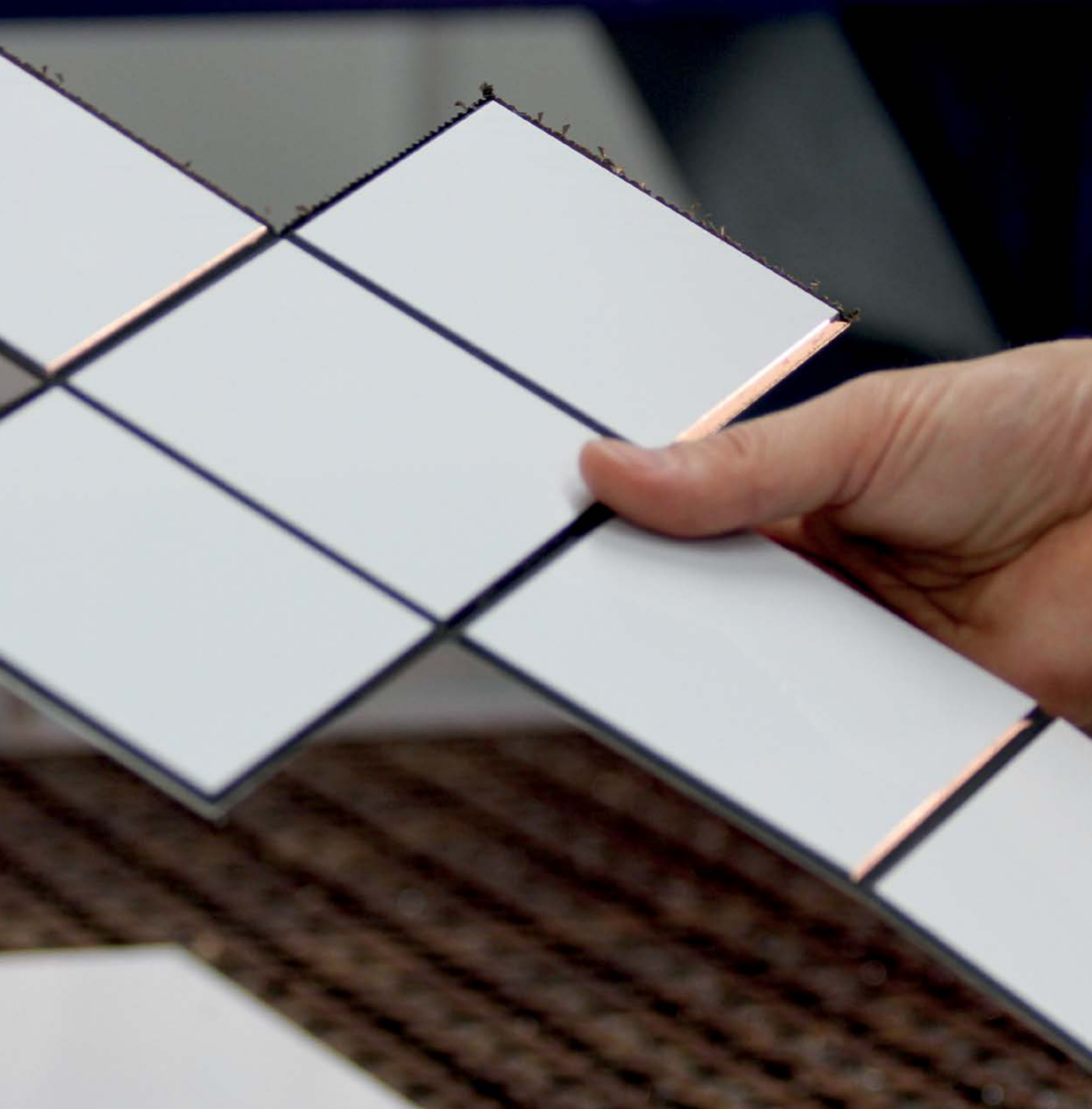

FR

L'EXPÉRIENCE

Depuis plus de 50 ans, LMT BELIN a acquis son expérience en relevant les challenges et les défis technologiques proposés par ses clients et partenaires les plus exigeants, dans de nombreux métiers (aéronautique, automobile, PLV, horlogerie, lunetterie...).

LE SAVOIR-FAIRE

Pour répondre à l'évolution de vos besoins, la société LMT BELIN s'est organisée autour de projets-client : un service commercial à l'écoute de vos demandes, une équipe de techniciens d'application experte dans chaque métier, un personnel formé en continu et équipé de machines flexibles et modernes, un bureau d'étude muni de moyens spécifiques de conception. Grâce au professionnalisme de ses équipes et afin de conduire au mieux vos projets, LMT BELIN s'engage à vous fournir la solution intégrée dans les meilleurs délais.

LA QUALITÉ

Reconnue à travers le monde pour la qualité de ses outils coupants (finition des goujures poliglacées et acuité d'arête exceptionnelle) la société LMT BELIN exige de ses fournisseurs des matières premières irréprochables afin de vous assurer des performances optimales. Nous nous engageons ainsi à vos côtés dans la réalisation de gains de productivité significatifs.

LMT Belin est certifié ISO 9001:2008.

LE SERVICE

Une fois vos outils conçus, nos techniciens vous accompagnent dans leur mise au point avec un maximum de réactivité jusqu'au fonctionnement optimal. Un service d'ingénierie est également à votre disposition pour vos études de process d'usinage. N'hésitez pas à nous contacter afin d'étudier ensemble vos projets, notre équipe est en permanence à votre écoute. Les catalogues présentant nos gammes d'outils coupants standards et spécifiques à chaque métier sont à votre disposition sur simple demande ou sur internet : www.lmt-belin.com

EN

EXPERIENCE

For over 50 years, LMT BELIN has acquired its experience by raising the technical challenges proposed by its customers and partners, from the most demanding to the most prestigious in numerous domains (aeronautic, automotive, watchmakers and optical industries).

THE KNOW-HOW

To answer to the development of your needs, the company LMT BELIN is organized around customer's projects: a sales team listens to your requirements, a team of application engineers, experts in each field, a staff who is continuously trained and equipped with flexible and modern machines, a design office equipped with specific design tools. Thanks to the professionalism of its teams and in order to manage your projects in the best possible way, LMT BELIN is committed to supply you with an integrated solution in the shortest timescale with state-of-the-art tooling solutions.

QUALITY

Recognized worldwide for the quality of its cutting tools (mirror finished grooves and an exceptionally accurate edge) LMT BELIN demands from its suppliers materials of the highest quality in order to ensure the best performance. We therefore work with you in order to achieve significant production benefits in your process time. LMT Belin is ISO 9001:2008 certified.

SERVICE

Once the tool has been developed, our technicians will assist you in your optimization with a maximum reactivity until optimal performance is reached. An engineering service is also at your disposal for your tooling process studies. Please do not hesitate to contact us so that we may study and assist your projects. Our team is permanently at your disposal. The catalogues presenting our range of standard and specific cutting tools to each trade are available upon request and on www.lmt-belin.com

DE

ERFAHRUNG

LMT BELIN kann auf mehr als 50 Jahre Erfahrung zurückblicken, in denen wir in zahlreichen Bereichen (Luftfahrt, Automobil, Uhren, Brillenindustrie...) die technischen Herausforderungen unserer anspruchsvollsten Kunden und Partner angenommen haben.

KNOW-HOW

Um Ihnen sich wandelnden Anforderungen gerecht zu werden, hat LMT BELIN eine Organisation um die Kundenprojekte herum aufgebaut : einen Vertrieb, der jederzeit für Ihre Anfragen zur Verfügung steht, eine Mannschaft von Anwendungstechnikern, die in allen Bereichen erfahren ist, laufend geschulte Mitarbeiter, die über flexible und moderne Maschinen verfügen sowie eine mit speziellen Projektierungsmitteln ausgestattete Konstruktionsabteilung. Dank der Professionalität der Teams und zur optimalen Ausführung Ihrer Projekte, verpflichtet sich LMT BELIN, Ihnen eine integrierte Lösung innerhalb der bestmöglichen Frist zu liefern.

QUALITÄT

LMT BELIN ist weltweit für die Qualität seiner Schneidwerkzeuge bekannt (Finish Bearbeitung der hochglanzpolierten Spannuten und hervorragende Scharfe der Schnittkanten) und verlangt daher von seinen Lieferanten einwandfreie Rohstoffe, um Ihnen eine optimale Standzeit bieten zu können. Wir stehen daher bei der Verwirklichung von bedeutenden Produktivitätsgewinnen an Ihrer Seite. LMT Belin ist ISO 9001:2008 zertifiziert.

SERVICE

Im Anschluss an die Entwicklung der Werkzeuge werden Sie von unseren Technikern, mit größter Reaktionsbereitschaft, beim Werkzeugeinsatz unterstützt, bis die optimale Funktion erreicht ist. Ein verfahrenstechnischer Dienst für die Entwicklung Ihrer Bearbeitungsprozesse steht Ihnen ebenfalls zur Verfügung. ont à votre disposition sur simple demande ou sur internet : www.lmt-belin.com

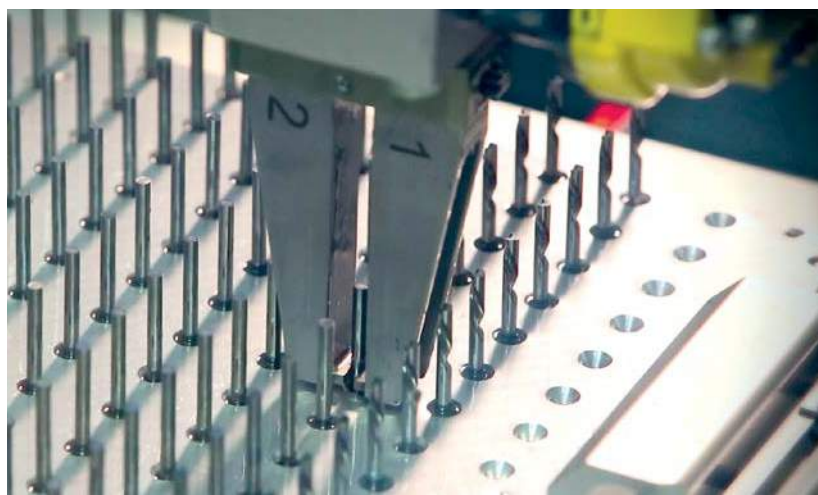

Fraisage

10 Milling / Fräsen

Cat-Nr 12 000 12

Fraises carbure monobloc EG - Hélice à gauche
EG solid carbide Milling cutters downcut /
VHM Einschneider mit Linksdrall

Plastiques, foam board, bois
Plastic, foam board, wood |
Kunststoff, Schaumstoff, Holz



Cat-Nr 13 000 13

Fraise carbure monobloc ED - Hélice à droite
Solid carbide ED Milling cutters upcut /
VHM Einschneider mit Rechtsdrall

Plastiques, foam board, bois
Plastic, foam board, wood |
Kunststoff, Schaumstoff, Holz



Cat-Nr 53 000 14

Fraises carbure monobloc CRISTAL
CRISTAL Solid carbide endmill / Vollhartmetallfräser CRISTAL

Plastiques et métaux non ferreux
Plastics and non-ferrous metals |
Kunststoff und Nichteisenmetalle



Décolletage de Fraises standards 15

Standard tools necked on demand / Freigeschliffene Fräser (Standard)

Cat-Nr 22-200 + 33 000 16

Fraises une dent carbure monobloc EGA / EDA
Solid carbide singleflute endmills /
VHM Einschneider

Métaux non ferreux
Non ferrous metals |
Nichteisenwerkstoffe



Cat-Nr GDA + XGDA 17

NEW

Fraises une dent carbure monobloc GDA / XGDA
Solid carbide endmill GDA - XGDA /
Einschneidenfräser GDA-XGDA

Métaux non ferreux
Non ferrous metals |
Nichteisenwerkstoffe



Cat-Nr 176 000 + 16 000 18

Fraises carbure monobloc à rainurer
Solid carbide slotting cutters / VHM Nutenfräser

Aluminium
Aluminium | Aluminium

Métaux ferreux (acier, inox, etc...)
Ferrous metals (steel, stainless steel, etc...)
Eisenwerkstoffe (Stahl, Inox, usw...)



Cat-Nr 102 000 + 15 000 19

Fraises carbure monobloc 3 et 4 dents
Solid carbide 3 to 4 flutes milling cutters /
2-4 schneiden VHM Schafffräser

Métaux ferreux (acier, inox, etc...)
Ferrous metals (steel, stainless steel, etc...)
Eisenwerkstoffe (Stahl, Inox, usw...)



Cat-Nr 43 000 + 193 000 20

Fraises carbure monobloc deux dents
2 teeth solid carbide milling cutters /
VHM 2-Schneidenfräser

Laminé, Composites
Laminate, Composites |
Laminierte Holzplatte, Composites

Plastiques, foam board, bois
Plastic, foam board, wood |
Kunststoff, Schaumstoff, Holz



Cat-Nr R 21

Fraises R - Plaquettes carbure brasées
R cutters - carbide tipped cutters /
R Fräser mit gelöteten HM Platten

Plastiques
Plastics | Kunststoff



Cat-Nr 02105 + TRESPA NEW 22

Fraises carbure monobloc - Matériaux spéciaux
Solid carbide milling cutters - Special materials /
Sondermaterial VHM Fräser

Plastiques chargés en fibres de verre (< 40%)
Glassfiber reinforced plastics GFRP (< 40%) |
Glasfaserverstärkte Kunststoffe (< 40%)



Matériaux composites (abrasifs), Nid d'abeille densifié, ...
Composite materials (abrasive), denser honeycomb, ... |
Kompositenmaterialien, verdichten Honeycomb, ...



Cat-Nr 60-200 NEW 23

Fraises carbure monobloc - Matériaux spéciaux
Solid carbide milling cutters - Special materials /
Sondermaterial VHM Fräser

Mousse
Foam board | Schaumstoff



Présentation SAPHIR 24

PCD SAPHIR Mill / PKD SAPHIR Fräser

Cat-Nr 205 000 + 206 000 NEW 25

Fraise SAPHIR PCD de finition
PCD SAPHIR Mill / SAPHIR Fräser mit gelötete PKD Platte

Plastiques
Plastics | Kunststoff



Cat-Nr 61 000 + 95 000 26

Fraises carbure monobloc - Matériaux spéciaux
Solid carbide milling cutters - Special materials /
Sondermaterial VHM Fräser

Plastiques thermoformés
Thermo-moulded plastics
Thermoplaste
Plastiques, plastiques thermoformés, bois
Plastics, Thermosets plastics, wood
Kunststoff, Thermoplaste, Holz



Cat-Nr DE 27

Fraises à surface DE - Plaquettes carbure brasées
DE surface cutters - carbide tipped cutters /
Planfräser DE mit gelöteten HM Platten

Plastiques, foam board, bois dur
Plastic, foam board, hard wood |
Kunststoff, Schaumstoff, Hartholz



Cat-Nr DE 28

Fraises à surface DE - Plaquettes carbure brasées
DE surface cutters - carbide tipped cutters /
Planfräser DE mit gelöteten HM Platten

Plastiques, foam board, bois dur
Plastic, foam board, hard wood |
Kunststoff, Schaumstoff, Hartholz



Cat-Nr DEPCD 29

Fraises à surfacer PCD
PCD Face milling cutters /
Planfräser DEPCD mit gelöteten PKD Platten

Plastiques, bois, non ferreux
Plastic, wood, non-ferrous metals |
Kunststoff, Holz, Nichteisenwerkstoffe



Cat-Nr DEPCDR 29

Fraises à surfacer PCD avec rayon
PCD Face milling cutter with radius /
Planfräser mit Radius DEPCDR mit gelöteten PKD Platten

Plastiques, bois, non ferreux
Plastic, wood, non-ferrous metals |
Kunststoff, Holz, Nichteisenwerkstoffe



Outils spéciaux pour l'enseigne 30

Special tools for sign-making / Sonderwerkzeugen für Werkstoffbearbeitung

Demande de fraise sur mesure 31

Inquiry form customized mills / Anfrageformblatt Sonderfräser

Fraisage de forme

Milling / Fräsen

32

Cat-Nr 117 000 + 52 000

NEW

Fraises carbure monobloc hémisphériques
Solid carbide Ball nose endmill / VHM Kugelschaftfräser

Plastiques, foam board, bois, résine
Plastic, foam board, wood, resin |
Kunststoff, Schaumstoff, Holz, Harz



34

Cat-Nr 65 200

NEW

Fraises carbure monobloc hémisphériques super finition
Superfinish Ball nose endmill / Superfinish Kugelschaftfräser

Plastiques, foam board, bois, résine
Plastic, foam board, wood, resin |
Kunststoff, Schaumstoff, Holz, Harz



35

Cat-Nr EDC + EDR

Fraises de forme carbure monobloc - Hélicoïdales
Solid carbide form milling cutters / VHM Stichelfräser

Plastiques, foam board, bois
Plastic, foam board, wood |
Kunststoff, Schaumstoff, Holz



36

Cat-Nr EDAC + EDAR

Fraises de forme carbure monobloc - Hélicoïdales
Solid carbide form milling cutters / VHM Stichelfräser

Métaux non-ferreux
Non-ferrous metals |
Nichteisenwerkstoffe



37

Cat-Nr NPR + NPRC

Fraises coniques plaquettes carbure brasées
Conical cutters carbide tipped /
Konischer Fräser mit gelöteten HM Platten

Plastiques, foam board, bois dur
Plastic, foam board, hard wood |
Kunststoff, Schaumstoff, Hartholz



Plastiques tendres, nylon, bois tendre
Soft plastics, nylon, soft wood |
Weicher Kunststoff Nylon, weicher Holz



38

Cat-Nr IED

Fraises pour extérieur IED plaquettes carbure brasées
Contour milling cutter IED / Aussenfräser IED

Plastiques, foam board, bois dur
Plastic, foam board, hard wood |
Kunststoff, Schaumstoff, Hartholz



39

Cat-Nr NPCRD

Fraise conique plaquettes PCD brasées
Conical cutter PCD tipped /
Konischerfräser mit gelöteten PKD Platten

Plastiques, bois, non ferreux
Plastic, wood, non-ferrous metals |
Kunststoff, Holz, Nichteisenwerkstoffe



39

Cat-Nr PLIH + PLI

NEW

Fraises carbure monobloc spéciales pour pliage
Solid carbide special cutters for folding /
VHM Spezialfräser zum Abkanten

Alucobond et métaux non ferreux
Alucobond and non-ferrous metals |
Alucobond und Nichteisenwerkstoffe



Plastiques
Plastics | Kunststoff



40

Cat-Nr FCOB

Fraises spéciales pour pliage plaquettes carbure brasées
Carbide tipped cutters special for folding /
Spezialfräser zum Abkanten mit HM gelötet Platte

Alucobond
Alucobond | Alucobond



41

Cat-Nr DR **42**

Fraises carbure monobloc bout sphérique DR
Solid carbide spherical cutters DR / VHM Kugelfräser DR

Plastiques, foam board, bois dur
Plastic, foam board, hard wood |
Kunststoff, Schaumstoff, Hartholz



Cat-Nr DR **42**

Fraises bout sphérique plaquettes carbure brasées
Carbide tipped spherical cutters DR /
DR Kugelfräser mit gelöteten HM Platten

Plastiques, foam board, bois dur
Plastic, foam board, hard wood |
Kunststoff, Schaumstoff, Hartholz



Cat-Nr P **43**

Fraise carbure monobloc droite à graver
Straight engraving mill P / Gravierfräser P

Plastiques, foam board, bois dur
Plastic, foam board, hard wood |
Kunststoff, Schaumstoff, Hartholz



44 **Gravage**
Engraving / Gravur

Cat-Nr 212 000 **46**

NEW

Fraise à graver PCD superfinition
Superfinish Engraving cutters / Superfinish PKD Gravierfräser

Matières plastiques et métaux non ferreux
Plastics and non-ferrous metals |
Kunststoff und Nichteisenwerkstoffe



Cat-Nr GR **47**

Fraises à graver carbure monobloc
Solid carbide engraving mill / VHM Gravierfräser

Plastiques, bois, non ferreux
Plastic, wood, non-ferrous metals |
Kunststoff, Holz, Nichteisenwerkstoffe



Cat-Nr GR **48**

Fraises à graver carbure monobloc
Engraving cutters / VHM Gravierfräser

Tous matériaux
All types of materials |
Alle Materialien



Cat-Nr GR **49**

Fraise à graver carbure monobloc pour machine gravograph
Solid carbide engraving mill for Gravograph Machine /
VHM Gravierfräser für Gravograph Maschine

Tous matériaux
All types of materials |
Alle Materialien



Cat-Nr GRP **49**

Fraise à graver pyramidale carbure monobloc GRP
revêtue "X TIALN"
Solid carbide pyramidal Engraving cutter GRP "X TIALN" coated /
VHM Gravierfräser GRP "X TIALN" beschichtet

Fraise spéciale pour usinage de forme ou gravage de matériaux
durs (acier inox, acier traité)
Special cutter for form manufacturing or engraving hard materials
(stainless steel, treated steel)
Sonderfräser für Formherstellung oder für Gravierung von harten
Materialien (Stahl inox, behandeltem Stahl)



50 **Couteaux de semi-découpe**
Knives / Klingen zum Schneiden von selbstklebenden Folien

Développement d'outils spéciaux **55**

Special tools development / Sonderwerkzeuge

56 **Accessoires**
Accessories / Zubehör

60 **Conseils techniques**
Technical notes / Technische Anmerkungen

Fraisage

Milling
Fräsen

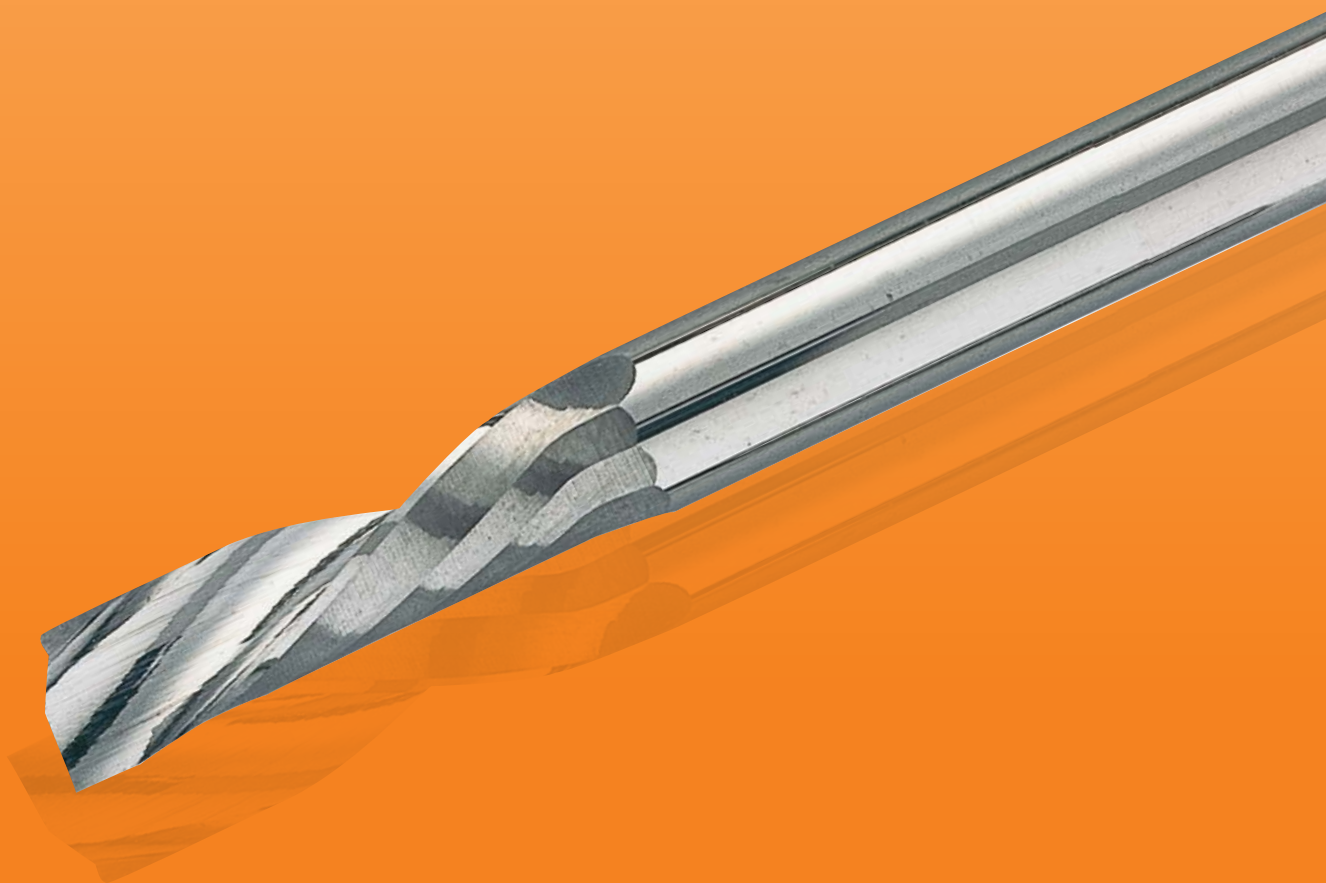

Plastiques, foam board, bois
Plastic, foam board, wood | Kunststoff, Schaumstoff, Holz

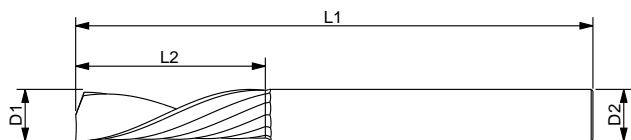

Cat-Nr 12000		Ø D1	Ø D2	L2	L1	z
Ref.	LMT- Code	mm	mm	mm	mm	
MÉTRIQUE						
2700279	12010	1	3	4	30	1
2700281	12015	1,5	3	6	30	1
2700025	12020	2	2	8	30	1
2701844	12020A	2	2	8	60	1
2700282	12020B	2	3	8	30	1
2700254	12025	2,5	2,5	8	30	1
2701846	12025A	2,5	2,5	8	60	1
2703050	12030	3	3	10	30	1
2701847	12030A	3	3	10	60	1
2700283	12030B	3	6	10	50	1
2700256	12040	4	4	12	50	1
2701849	12040A	4	4	20	60	1
2701850	12040B	4	4	30	70	1
2700284	12040C	4	6	12	50	1
2700257	12050	5	5	16	60	1
2701852	12050A	5	5	30	70	1
2700285	12050B	5	6	16	60	1
2700258	12060	6	6	20	60	1
2701843	12060A	6	6	30	70	1
2701841	12060B	6	6	38	80	1
2700259	12080	8	8	22	60	1
2701854	12080A	8	8	38	80	1
2700260	12100	10	10	30	75	1
2700261	12120	12	12	30	75	1

Cat-Nr 12000		Ø D1		Ø D2		L2		L1		z
Ref.	LMT- Code	mm	inch	mm	inch	mm	inch	mm	inch	
INCH										
2701848	12317	3,17	1/8"	6,35	1/4"	12,7	1/2"	38,1	1 1/2"	1
2701851	12476	4,76	3/16"	6,35	1/4"	15,87	5/8"	50,8	2"	1
2701853	12635	6,35	1/4"	6,35	1/4"	19,05	3/4"	50,8	2"	1



CONSEIL D'EXPERTS

Le copeau est projeté en bout de fraise. Un espace entre la table de la machine et la pièce est nécessaire pour l'évacuation du copeau.

/ The chips are ejected through the end of the cutter.

A space between the material and the cutting table is necessary to clear the chips

/ Die Späne werden an der Spitze des Fräasers abgehört. Zum Abführen der Späne ist ein Abstand zwischen Material und Maschinentisch erforderlich

Plastiques, foam board, bois
Plastic, foam board, wood | Kunststoff, Schaumstoff, Holz

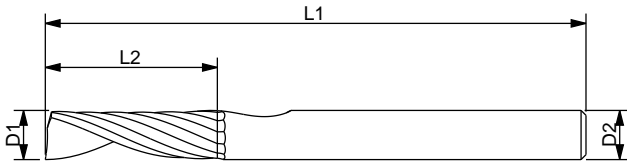

Cat-Nr 13000		Ø D1	Ø D2	L2		L1		z
Ref.	LMT-Code	mm	mm	mm	mm	mm	mm	
2750696	13018	1,8	3	6	30	1		
2700280	13010	1	3	4	30	1		
2750688	13011	1,1	3	4	30	1		
2750690	13012	1,2	3	4	30	1		
2750692	13014	1,4	3	4	30	1		
2700286	13015	1,5	3	6	30	1		
2750694	13016	1,6	3	6	30	1		
2700132	13020	2	2	8	30	1		
2701855	13020A	2	2	8	60	1		
2700287	13020B	2	3	8	30	1		
2728731	13020C	2	6	8	50	1		
2700262	13025	2,5	2,5	8	30	1		
2701856	13025A	2,5	2,5	8	60	1		
2700263	13030	3	3	10	30	1		
2817688	13030F	3	3	12	40	1		
2731105	13030E	3	3	15	40	1		
2701867	13030A	3	3	10	60	1		
2700288	13030B	3	6	10	50	1		
2817690	13030G	3	6	12	50	1		
2709117	13030C	3	3	20	60	1		
2709118	13030D	3	6	20	60	1		
2700264	13040	4	4	12	50	1		

Cat-Nr 13000		Ø D1	Ø D2	L2		L1		z
Ref.	LMT-Code	mm	mm	mm	mm	mm	mm	
2828107	13040F	4	4	14	50	1		
2828108	13040G	4	4	22	60	1		
2701860	13040B	4	4	30	70	1		
2700289	13040C	4	6	12	50	1		
2828109	13040H	4	6	14	50	1		
2828110	13040J	4	6	22	60	1		
2734847	13040E	4	4	12	40	1		
2700265	13050	5	5	16	60	1		
2819576	13050C	5	5	22	60	1		
2817700	13050D	5	6	22	60	1		
2701861	13050A	5	5	30	70	1		
2700290	13050B	5	6	16	60	1		
2817702	13060C	6	6	14	50	1		
2867836	13060D	6	6	22	60	1		
2828111	13060E	6	6	32	70	1		
2701863	13060B	6	6	38	80	1		
2700267	13080	8	8	22	60	1		
2817710	13080B	8	8	32	70	1		
2701865	13080A	8	8	38	80	1		
2817712	13080C	8	8	42	80	1		
2700268	13100	10	10	30	75	1		
2700269	13120	12	12	30	75	1		

Cat-Nr 13000		Ø D1		Ø D2		L2		L1		z
Ref.	LMT-Code	mm	inch	mm	inch	mm	inch	mm	inch	
2701858	13317	3,17	1/8"	6,35	1/4"	12,7	1/2"	38,1	1 1/2"	1
2703218	13317A	3,17	1/8"	3,17	1/8"	12,7	1/2"	50,8	2"	1
2701866	13476	4,76	3/16"	6,35	1/4"	15,87	5/8"	50,8	2"	1
2703219	13476A	4,76	3/16"	4,76	3/16"	15,87	5/8"	50,8	2"	1
2709114	13476B	4,76	3/16"	6,35	1/4"	31,75	1 1/4"	76,2	3"	1
2701864	13635	6,35	1/4"	6,35	1/4"	19,05	3/4"	50,8	2"	1
2709115	13635A	6,35	1/4"	6,35	1/4"	38,1	1 1/2"	76,2	3"	1
2743445	13635B	6,35	1/4"	6,35	1/4"	58	2 1/4"	95,25	3 3/4"	1
2750260	13635C	6,35	1/4"	6,35	1/4"	28	1 1/8"	76,2	3"	1
2743447	13952	9,52	3/8"	9,52	3/8"	28,57	1 1/8"	76,2	3"	1
2743449	13952A	9,52	3/8"	9,52	3/8"	80,96	3 3/16"	127	5"	1
2709116	13127	12,7	1/2"	12,7	1/2"	31,75	1 1/4"	76,2	3"	1
2751019	13127A	12,7	1/2"	12,7	1/2"	50,8	2"	102	4"	1



CONSEILS D'EXPERTS

La pièce usinée doit être parfaitement bien maintenue par procédé Vacuum ou autre.
/ The chips are ejected on the shank side of the tool. Ideally used on machines with a vacuum process, this cutter allows a good surface state
/ Die spanne werden seitlich am Ende des Werkzeuges abgef. hrt. Bei Verwendung von Maschinen mit Vakuum-Vorrichtung erlauben die Fr. ser eine gute Oberflächenqualität

Plastiques et métaux non ferreux
 Plastics and non-ferrous metals | Kunststoff und Nichteisenmetal

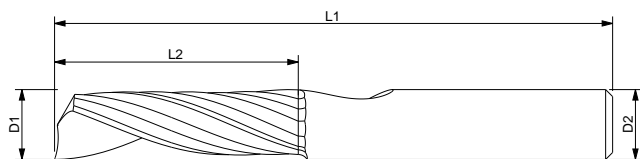

Cat-Nr 53 000		Ø D1	Ø D2	L2	L1	z
Ref.	LMT-Code	mm	mm	mm	mm	
MÉTRIQUE						
2823827	53030	3	3	9	30	1
2823828	53040	4	4	13	50	1
2803593	53040A	4	6	13	50	1
2823830	53060	6	6	16	50	1
2823831	53080	8	8	20	60	1
2823832	53100	10	10	23	60	1



Cat-Nr 53 000		Ø D1		Ø D2		L2		L1		z
Ref.	LMT-Code	mm	inch	mm	inch	mm	inch	mm	inch	
INCH										
2864636	53476	4,76	3/16"	4,76	3/16"	12,7	1/2"	38,1	1 1/2"	1
2864637	53635	6,35	1/4"	6,35	1/4"	16	5/8"	50,8	2"	1
2864638	53952	9,52	3/8"	9,52	3/8"	25,4	1"	60,32	2 3/8"	1



CONSEILS D'EXPERTS

Géométrie spécialement développée pour le détournage de panneaux de plastiques et métaux non-ferreux.

Cette gamme permet :

- Augmentation des vitesses d'avance dans les matériaux plastiques
 - Amélioration des états de surface dans les matériaux plastiques
- Privilégier un diamètre équivalent à l'épaisseur de la matière à usiner.

/ The CRISTAL range of endmills give better results in surface quality, tool life and a geometry allowing plastics and non-ferrous metals machining.

/ Die VHM Schaftfräser CRISTAL bringt Ihnen eine optimale Oberflächenqualität, eine langer Standzeit und eine spezielle Geometrie für Kunststoff und Nichteisenmetal

Ce feuillet peut être utilisé pour toutes vos demandes de décolletage sur fraises standards.

This form can be filled in for all your necked standard tools request.

bitte dieses Formblatt ausfüllen damit wir Ihnen die freigeschliffene Fräser anbieten können.

Société / Firm / Firma :

Adresse / Address / Adresse :

CP Ville / Zip City / PLZ-Stadt :

Pays / Country / Land :

Votre distributeur / Your official retailer / Ihre Verteiler :

<p>Fraise standard de référence Standard reference to neck / Referenzfräser (z.B 13060)</p>	<p>.....</p> <p>.....</p> <p>.....</p>	<p>L2 :</p> <p>L3 :</p> <p>D3 :</p>
--	--	--

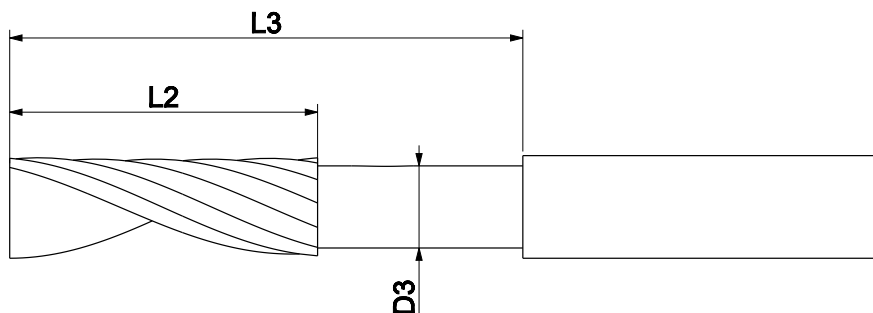

Vous pouvez nous renvoyer ce plan par fax au 04 74 75 89 90 ou par E-Mail à service.client@lmt-belin.com

You can send the sheet by fax at 0033 474 758 990 or by E-Mail customer.service@lmt-belin.com

Sie können dieses Formblatt per Fax an 0033 474 758 990 oder per E-Mail an : customer.service@lmt-belin.com schicken



Métaux non ferreux

Non ferrous metals | Nichteisenwerkstoffe

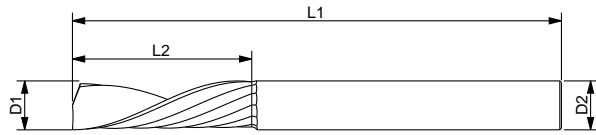

Cat-Nr 22 000		Ø D1	Ø D2	L2	L1	z
Ref.	LMT-Code	mm	mm	mm	mm	
MÉTRIQUE						
2700139	22015	1.5	3	4	30	1
2700051	22020	2	3	5	30	1
2700140	22025	2.5	3	6	30	1
2700141	22030	3	3	8	30	1
2700142	22040	4	4	12	60	1
2700147	22040A	4	6	10	50	1
2700143	22050	5	5	16	60	1
2700148	22050A	5	6	12	50	1
2700144	22060	6	6	15	50	1
2700145	22080	8	8	20	60	1
2700146	22100	10	10	23	60	1



Cat-Nr 22 000		Ø D1		Ø D2		L2		L1		z
Ref.	LMT-Code	mm	inch	mm	inch	mm	inch	mm	inch	
INCH										
2730637	22317	3,17	1/8"	6,35	1/4"	7,93	5/16"	38,1	1 1/2"	1
2724106	22476	4,76	3/16"	6,35	1/4"	12	1/2"	50,8	2"	1
2730641	22635	6,35	1/4"	6,35	1/4"	15	5/8"	50,8	2"	1



CONSEILS D'EXPERTS

Le copeau est projeté en bout de fraise. Un espace entre la table de la machine et la pièce est nécessaire pour l'évacuation du copeau.

/ The chips are ejected through the end of the cutter. A space between the material and the cutting table is necessary to clear the chips.

/ Die Späne werden an der Spitze des Fräses abgeföhrt. Zum Abföhren der Späne ist ein Abstand zwischen Material und Maschinentisch erforderlich.



Métaux non ferreux

Non ferrous metals | Nichteisenwerkstoffe

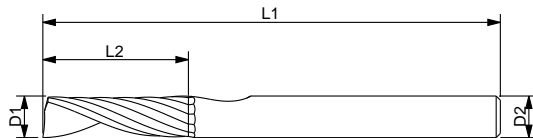

Cat-Nr 33 000		Ø D1	Ø D2	L2	L1	z
Ref.	LMT-Code	mm	mm	mm	mm	
MÉTRIQUE						
2700149	33015	1,5	3	4	30	1
2700131	33020	2	3	5	30	1
2700150	33025	2,5	3	6	30	1
2700151	33030	3	3	8	30	1
2700153	33040	4	4	12	60	1
2700154	33040A	4	6	10	50	1
2760622	33040B	4	4	30	70	1
2700156	33050	5	5	16	60	1
2700157	33050A	5	6	12	50	1
2758088	33050B	5	5	30	70	1
2758086	33050C	5	8	25	70	1
2760621	33050D	5	8	35	80	1
2700158	33060	6	6	15	50	1
2754630	33060A	6	6	15	70	1
2758092	33060B	6	6	20	60	1
2758094	33060C	6	6	30	70	1
2758096	33060D	6	6	38	80	1
2758090	33060E	6	8	30	80	1
2700160	33080	8	8	20	60	1
2754632	33080A	8	8	20	80	1
2758100	33080B	8	8	38	80	1
2700161	33100	10	10	23	60	1
2754634	33100A	10	10	23	100	1
2758102	33100B	10	10	30	75	1



Cat-Nr 33 000		Ø D1		Ø D2		L2		L1		z
Ref.	LMT-Code	mm	inch	mm	inch	mm	inch	mm	inch	
INCH										
2700152	33317	3,17	1/8"	6,35	1/4"	8	5/16"	38,1	1 1/2"	1
2709120	33317A	3,17	1/8"	3,17	1/8"	8	5/16"	38,1	1 1/2"	1
2700155	33476	4,76	3/16"	6,35	1/4"	12	1/2"	50,8	2	1
2709121	33476A	4,76	3/16"	4,76	3/16"	12	1/2"	50,8	2	1
2781274	33476B	4,76	3/16"	4,76	3/16"	15,9	5/8"	50,8	2	1
2700159	33635	6,35	1/4"	6,35	1/4"	15	5/8"	50,8	2	1
2744581	33952	9,52	3/8"	9,52	3/8"	25,4	1	76,2	3	1
2744583	33127	12,7	1/2"	12,7	1/2"	28,57	1 1/8"	88,9	3 1/2"	1



CONSEILS D'EXPERTS

Le copeau est remonté vers la queue de l'outil. La pièce usinée doit être parfaitement bien maintenue par procédé Vacuum ou autre.

/ The chips are ejected towards the shank of the cutter. Most popular design as vacuum directly above the tool offers a very clean and efficient operation.

/ Die Späne werden seitlich am Ende des Werkzeuges abgeföhrt. Bei Verwendung von Maschinen mit Vakuumvorrichtung erlauben die Fräser eine sehr gute Oberflöhchenqualität.



Métaux non ferreux

Non ferrous metals | Nichteisenwerkstoffe

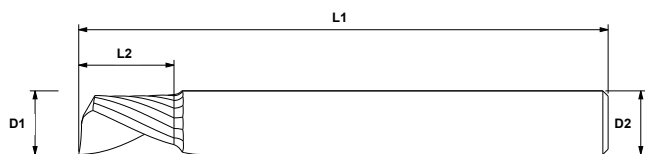

Cat-Nr GDA	Ø D1	Ø D2	L2	L1	z	
Ref.	LMT- Code	MÉTRIQUE				
2828082	GDA030	3	3	4,5	40	1
2828083	GDA030A	3	6	4,5	50	1
2828084	GDA040	4	4	6	50	1
2828085	GDA040A	4	6	6	50	1
2828086	GDA050	5	5	7,5	50	1
2828087	GDA060	6	6	9	50	1
2828088	GDA080	8	8	12	60	1
2828089	GDA100	10	10	15	65	1



CONSEILS D'EXPERTS

Géométrie spécialement développée pour le détourage de panneaux de métaux non-ferreux.

Cette gamme permet :
- L'augmentation des vitesses d'avance
- L'amélioration des états de surface

Privilégier un diamètre équivalent à l'épaisseur de la matière à usiner.

/ This tool geometry has been specially developed for non-ferrous panels machining.

This products allow you to :

- Increase cutting speeds
- Improve surface state

For best result we recommend you to choose a diameter close to the material thickness.

Machining with coolant highly recommended

/ Diese Produktpalette wurde speziell für die Bearbeitung von Nichteisenwerkstoffen entwickelt. Die Schnittgeschwindigkeiten können im Vergleich zu anderen Produktplatten erhöht werden. Die Verwendung von Schmiermitteln wird empfohlen.



Métaux non ferreux

Non ferrous metals | Nichteisenwerkstoffe

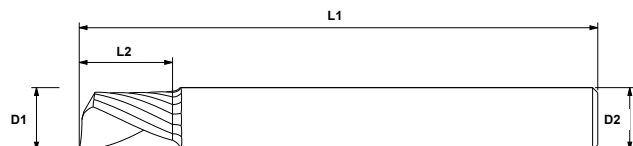

Cat-Nr XGDA	Ø D1	Ø D2	L2	L1	z	
Ref.	LMT- Code	MÉTRIQUE				
2828090	XGDA030	3	3	4,5	40	1
2830244	XGDA030A	3	6	4,5	50	1
2830245	XGDA040	4	4	6	50	1
2830247	XGDA040A	4	6	6	50	1
2830248	XGDA050	5	5	7,5	50	1
2828091	XGDA060	6	6	9	50	1
2830246	XGDA080	8	8	12	60	1
2828092	XGDA100	10	10	15	65	1



CONSEILS D'EXPERTS

Gamme identique dotée d'un revêtement anti-collage spécialement développé permettant l'usinage sans lubrification ou fortement réduite.

/ Same range of product with a specially developed coating to prevent chips bonding. Machining without coolant.

/ Das gleiche Werkzeug mit einer Sonderbeschichtung für eine längere Standzeit und die Bearbeitung ohne Kühlung.

Aluminium et métaux non-ferreux

Aluminium and non-ferrous metals | Aluminium und Nichteisenwerkstoffe

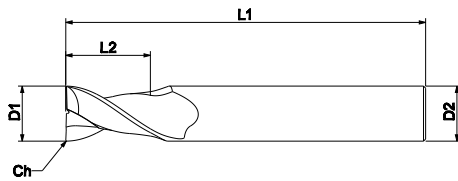

Cat-Nr 176 000		Ø D1	Ø D2	L2	L1	CH 45°	z
Ref.	LMT-Code	MÉTRIQUE					
2727733	176020	2	6	6	50	0,1	2
2727735	176030	3	6	7	50	0,1	2
2727321	176040	4	6	8	50	0,1	2
2727323	176050	5	6	10	50	0,2	2
2727737	176060	6	6	10	50	0,2	2
2727739	176080	8	8	15	60	0,2	2
2727741	176100	10	10	18	65	0,25	2
2727743	176120	12	12	20	70	0,25	2
2727745	176140	14	14	22	75	0,25	2
2727747	176160	16	16	25	80	0,3	2
6550080	176180	18	18	28	100	0,3	2
2727751	176200	20	20	35	100	0,3	2

Métaux ferreux (acier, inox, etc...)

Ferrous metals (steel, stainless steel, etc...) | Eisenmetallen (Stahl, Inox, usw...)

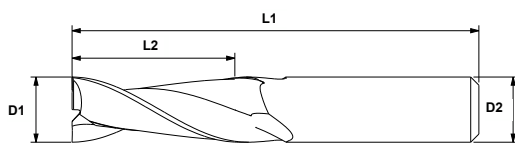

Cat-Nr 16 000		Ø D1	Ø D2	L2	L1	z
Ref.	LMT-Code	MÉTRIQUE				
2700058	16010	1	3	4	38	2
2700165	16015	1,5	3	4,5	38	2
2700112	16020	2	2	7	40	2
2700166	16020A	2	3	6,3	35	2
2700167	16025	2,5	2,5	8	40	2
2700168	16025A	2,5	3	9	38	2
2700169	16030	3	3	10	40	2
2700171	16040	4	4	11	48	2



Cat-Nr 16 000		Ø D1	Ø D2	L2	L1	z
Ref.	LMT-Code	MÉTRIQUE				
2700173	16050	5	5	13	60	2
2700175	16060	6	6	16	60	2
2700177	16070	7	7	20	60	2
2700180	16080	8	8	23	60	2
2700182	16090	9	9	23	60	2
2700184	16100	10	10	23	60	2
2700188	16120	12	12	30	76	2
2700192	16140	14	14	30	76	2

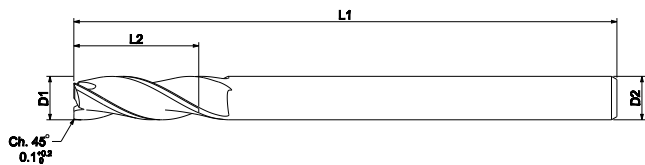

Cat-Nr 102 000		Ø D1	Ø D2	L2	L1	z
Ref.	LMT- Code	mm	mm	mm	mm	
MÉTRIQUE						
6550353	102020	2	2	7	40	3
6550000	102030	3	3	10	40	3
6550001	102040	4	4	11	48	3
6550002	102050	5	5	13	60	3
6550003	102060	6	6	16	60	3
6550004	102070	7	7	20	60	3
6550005	102080	8	8	23	60	3
6550006	102090	9	9	23	60	3
6550007	102100	10	10	23	60	3



Cat-Nr 102 000		Ø D1	Ø D2	L2	L1	z
Ref.	LMT- Code	mm	mm	mm	mm	
MÉTRIQUE						
6550008	102110	11	11	30	76	3
6550009	102120	12	12	30	76	3
6550010	102130	13	13	30	76	3
6550011	102140	14	14	30	76	3
6550012	102150	15	15	30	76	3
6550013	102160	16	16	32	80	3
6550014	102180	18	18	32	80	3
6550015	102200	20	20	38	90	3



Cat-Nr 102 000		Ø D1		Ø D2		L2		L1		z
Ref.	LMT- Code	mm	inch	mm	inch	mm	inch	mm	inch	
INCH										
2709122	102317	3,17	1/8"	6,35	1/4"	10	0.393"	40	1.574"	3
2709123	102476	4,76	3/16"	6,35	1/4"	11	0.433"	48	1.89"	3
2709124	102635	6,35	1/4"	6,35	1/4"	16	0.63"	60	2.362"	3

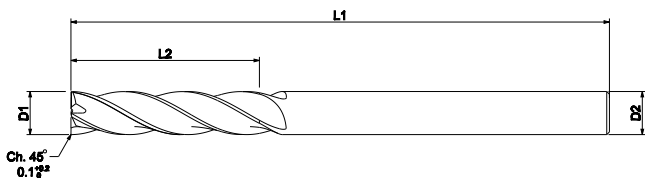

Cat-Nr 15 000		Ø D1	Ø D2	L2	L1	z
Ref.	LMT- Code	mm	mm	mm	mm	
MÉTRIQUE						
6550314	15010	1	3	4	38	4
6550315	15015	1,5	3	4,5	38	4
6550037	15020	2	2	7	40	4
6550384	15020A	2	3	6,3	35	4
2700197	15025	2,5	2,5	8	40	4
2706135	15025A	2,5	3	9	38	4
6550039	15030	3	3	10	40	4
6550040	15035	3,5	3,5	10	40	4
6550041	15040	4	4	11	48	4
6550042	15045	4,5	4,5	11	48	4
6550043	15050	5	5	13	60	4
2825803	15055	5,5	5,5	13	60	4



Cat-Nr 15 000		Ø D1	Ø D2	L2	L1	z
Ref.	LMT- Code	mm	mm	mm	mm	
MÉTRIQUE						
6550045	15060	6	6	16	60	4
6550046	15070	7	7	20	60	4
6550047	15080	8	8	23	60	4
6550057	15090	9	9	23	60	4
6550048	15100	10	10	23	60	4
6550049	15120	12	12	30	76	4
6550050	15140	14	14	30	76	4
6550052	15150	15	15	30	76	4
6550053	15160	16	16	32	80	4
2868163	15180	18	18	32	80	4
6550055	15200	20	20	38	90	4



Laminé, Composites
Laminate, Composites | laminierte Holzplatte, Composites

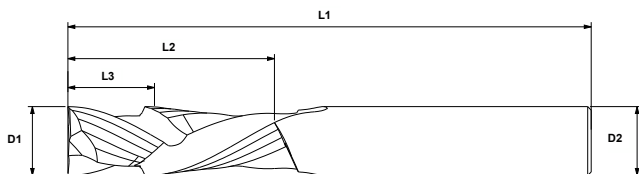

Cat-Nr 43 000		Ø D1	Ø D2	L2	L3	L1	z
Ref.	LMT-Code	mm	mm	mm	mm	mm	
MÉTRIQUE							
2709823	43060	6	6	22	11	76	2
2730648	43080	8	8	25	12,5	76	2
2709827	43100	10	10	30	15	76	2
2755506	43120	12	12	35	17,5	80	2

Cat-Nr 43 000		Ø D1		Ø D2		L2		L3		L1		z
Ref.	LMT-Code	mm	inch	mm	inch	mm	inch	mm	inch	mm	inch	
INCH												
2730650	43635	6,35	1/4"	6,35	1/4"	22,22	7/8"	11,1	7/16"	63,5	2 1/2"	2
2730646	43952	9,52	3/8"	9,52	3/8"	25,4	1"	12,7	1/2"	76,2	3"	2
2730652	43127	12,7	1/2"	12,7	1/2"	28,57	1 1/8"	14,3	9/16"	76,2	3"	2



CONSEILS D'EXPERTS

La double hélice à droite et à gauche permet un usinage en mode "Compression", afin de limiter les éclats et la délamination des surfaces extérieures.

/ The sharp edge combined with an upcut-downcut helix allows to cut soft plastics also with skin layers without generating burrs.

/ Die scharfen Schneiden und der Rechts-Linksdrill ermöglichen es, weiche Kunststoffe, auch mit Deckschichten, gratfrei zu besägen.

Plastiques, foam board, bois
Plastic, foam board, wood | Kunststoff, Schaumstoff, Holz

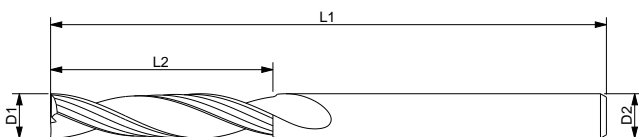

Cat-Nr 193 000		Ø D1	Ø D2	L2	L1	z
Ref.	LMT-Code	mm	mm	mm	mm	
MÉTRIQUE						
2758471	193050	5	5	20	70	2
2755602	193060	6	6	22	76	2
2755604	193080	8	8	25	76	2
2755606	193100	10	10	30	76	2
2757588	193120	12	12	35	80	2

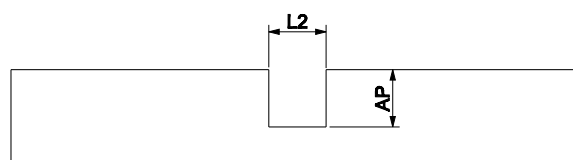
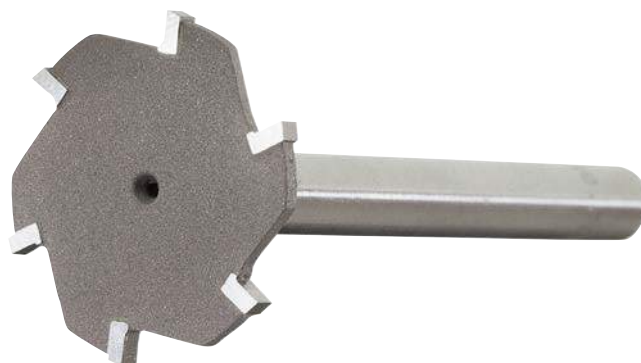
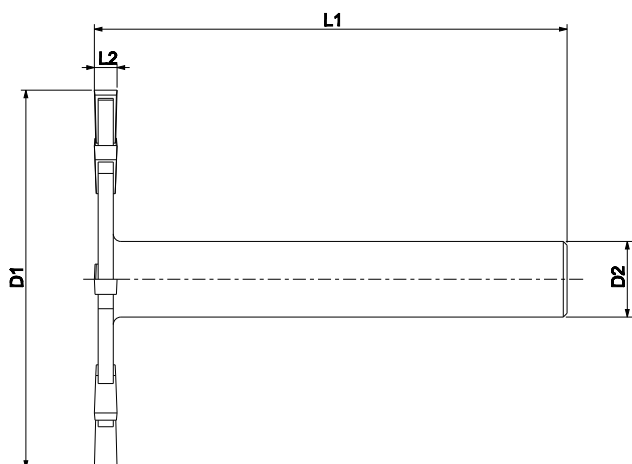

Cat-Nr R		Ø D1	Ø D2	L2	L1	z	Ap max
Ref.	LMT-Code	rotation à droite / right rotation / drehrichtung rechts					
2702129	18112	15	6	1,2	28	6	4
2702134	18114	15	6	1,4	28	6	4
2702135	18116	15	6	1,6	28	6	4
2702136	18118	15	6	1,8	28	6	4
2702137	18120	15	6	2	28	6	4
2702138	18010	25	6	1	26	6	8,5
2703248	95046	25	8	1	62	6	8,5
2702139	18011	25	6	1,1	26	6	8,5
2702140	18012	25	6	1,2	26	6	8,5
2702141	18013	25	6	1,3	26	6	8,5
2702142	18014	25	6	1,4	26	6	8,5
2702143	18015	25	6	1,5	26	6	8,5
2702144	18016	25	6	1,6	26	6	8,5
2702145	18018	25	6	1,8	26	6	8,5
2702146	18020	25	6	2	26	6	8,5
2702133	82321	25	6	2	62	6	8,5
2700078	90279	25	6	2	62	6	8,5
2702130	90241	35	6	2	62	8	13,5
2702131	90467	50	10	3	62	8	19

Cat-Nr R		Ø D1	Ø D2	L2	L1	z	Ap max
Ref.	LMT-Code	rotation à gauche / left rotation / drehrichtung links					
2702132	95154	25	6	2	62	6	8,5

Plastiques chargés en fibres de verre (< 40%)

Glassfiber reinforced plastics (GFRP < 40%) | Glasfaserverstärkte Kunststoffe (< 40%)

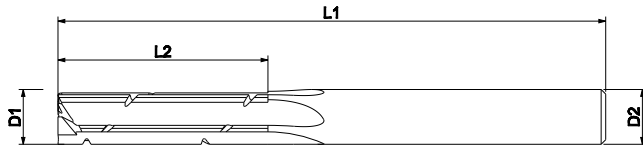

Cat-Nr 02105		Ø D1	Ø D2	L2	L1	z
Ref.	LMT-Code	mm	mm	mm	mm	
MÉTRIQUE						
2754636	02105A	5	5	19	60	5
2754638	02105B	6	6	23	60	5
2754640	02105C	8	8	30	70	5

Matériaux composites (abrasifs), Nid d'abeille densifié, ...

Composite materials (abrasive), denser honeycomb, ... | Kompositenmaterialien, verdichteten Honeycomb, ...

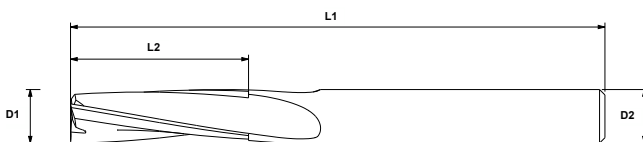
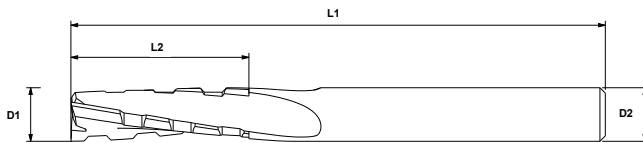

Cat-Nr TRESPA		Ø D1	Ø D2	L2	L1	z
Ref.	LMT-Code	mm	mm	mm	mm	
MÉTRIQUE						
2826279	TRESPAR6	6	6	20	60	3
2830889	TRESPAR8	8	8	20	64	3
2700049	TRESPAF6	6	6	20	60	3



CONSEILS D'EXPERTS

La fraise avec brise-copeaux (TRESPA-R) permet d'ébaucher vos pièces. Pour la finition, utilisez la fraise à denture lisse (TRESPA-F) pour de très bons états de surface.

/ The chip-breaker geometry (TRESPA-R) is perfectly suited for roughing operations. To get the best surface state possible use the finishing geometry (TRESPA-F).

/ Der spanbrechende Fräser (TRESPA-R) erlaubt eine Grobbearbeitung Ihrer Teile. Zur Endbearbeitung benutzen Sie den Fräser mit Schlichtschneide (TRESPA-F) für eine hervorragende Oberfläche.

NEW



Mousse

Foam board | Schaumstoff

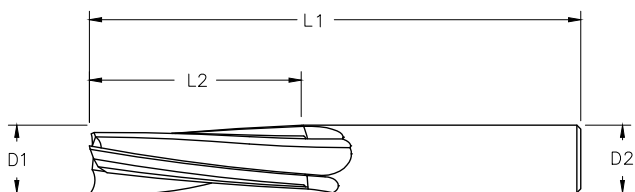

Cat-Nr 60-200		Ø D1		Ø D2		L2		L1		z
Ref.	LMT- Code	mm	inch	mm	inch	mm	inch	mm	inch	
7088755	60-239	6,35	1/4"	6,35	1/4"	9,52	3/8"	76,19	3"	3
7100389	60-241	6,35	1/4"	6,35	1/4"	22,23	7/8"	76,19	3"	3
7088756	60-243	9,52	3/8"	9,52	3/8"	15,88	5/8"	76,19	3"	3
2600889	60-245	9,52	3/8"	9,52	3/8"	28,58	1-1/8"	76,19	3"	3
7088757	60-249	12,7	1/2"	12,7	1/2"	28,58	1-1/8"	88,89	3-1/2"	3
6601431	60-251	12,7	1/2"	12,7	1/2"	53,98	2-1/8"	114,3	4-1/2"	3
2865347	60-253	12,7	1/2"	12,7	1/2"	41,28	1-5/8"	101,6	4"	3
2600893	60-269	19,04	3/4"	19,04	3/4"	41,28	1-5/8"	101,6	4"	3
2600895	60-271	19,04	3/4"	19,04	3/4"	53,98	2-1/8"	127	5"	3
2600897	60-277	19,04	3/4"	19,04	3/4"	79,38	3-1/8"	152,39	6"	3

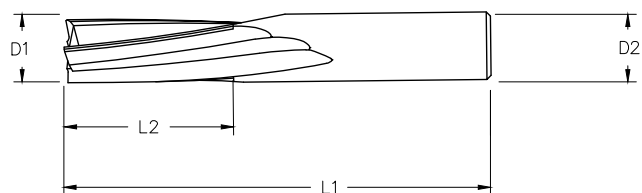

Cat-Nr 60-200		Ø D1		Ø D2		L2		L1		z
Ref.	LMT- Code	mm	inch	mm	inch	mm	inch	mm	inch	
6601420	60-240	6,35	1/4"	6,35	1/4"	9,52	3/8"	76,19	3"	3
7100391	60-242	6,35	1/4"	6,35	1/4"	22,23	7/8"	76,19	3"	3
2600888	60-244	9,52	3/8"	9,52	3/8"	15,88	5/8"	76,19	3"	3
2600890	60-246	9,52	3/8"	9,52	3/8"	28,58	1-1/8"	76,19	3"	3
2600891	60-250	12,7	1/2"	12,7	1/2"	28,58	1-1/8"	88,89	3-1/2"	3
6601432	60-252	12,7	1/2"	12,7	1/2"	53,98	2-1/8"	114,3	4-1/2"	3
2600892	60-254	12,7	1/2"	12,7	1/2"	41,28	1-5/8"	101,6	4"	3
2600894	60-270	19,04	3/4"	19,04	3/4"	41,28	1-5/8"	101,6	4"	3
2600896	60-272	19,04	3/4"	19,04	3/4"	53,98	2-1/8"	127	5"	3
2600898	60-278	19,04	3/4"	19,04	3/4"	79,38	3-1/8"	152,39	6"	3



FR

LMT Belin a développé une gamme de fraises de super finition dans les plastiques (type PMMA). Ces outils dont la partie utile est en Diamant Polycristallin (Diamant synthétique ou PCD) vous permettent la plupart du temps d'éviter le recours au polissage ou au flammage. De plus, cette gamme de produits vous garantira des durées de vie élevées et la possibilité de les réaffûter (selon expertise par nos soins)

- États de surface transparents
- Très longue durée de vie

EN

LMT Belin has developed a range of products for finishing operations in plastics (PMMA as an example). Those tools with a polycrystalline diamond insert (synthetic diamond – PCD) allow you to avoid polishing or flaming operations. Furthermore this range of tools will guarantee you long tool life and the possibility to regrind them (depending on our expert assessment)

- Clear surface state
- Long tool life thanks to PCD insert Each firm has its own competences and allows LMT Group to supply performing products throughout the whole world thanks to subsidiaries and exclusive partners.

DE

LMT Belin hat eine Produktpalette von Fräsern mit Superflächenausführung für Kunststoffe (Typ PMMA) entwickelt. Diese Werkzeuge, dessen Schneide aus Poly Kristallinem Diamant besteht (synthetischem Diamant oder PKD), erlaubt es in den meisten Fällen ein anschliessendes Polieren oder Beflammen zu vermeiden. Ausserdem garantiert Ihnen diese Produktpalette hohe Standzeiten und die Möglichkeit die Werkzeuge nachzuschleifen (in Abhängigkeit des Ergebnis unserer Begutachtung)

- Transparenter Oberflächenzustand
- hohe Standzeit



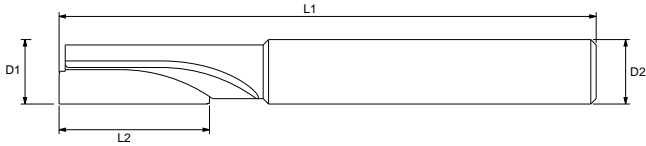

Cat-Nr 205 000		Ø D1	Ø D2	L2	L1	z
Ref.	LMT- Code	mm	mm	mm	mm	
MÉTRIQUE						
2825477	205030	3	6	6	50	1
2825594	205040	4	6	10	50	1
2818506	205060	6	6	14	50	1
2818352	205080	8	8	18	50	1
2825459	205100	10	10	22	60	1



CONSEILS D'EXPERTS

La fraise SAPHIR 205 permet d'obtenir des états de surface sur les flancs proche des résultats d'usinage au Diamant Naturel. Elle vous permettra aussi de réduire voir d'éliminer les opérations de flammage ou polissage sur les plastiques type PMMA. La coupe en bout vous permettra de réaliser des poches avec un état de surface mat.

/ The 205 SAPHIR milling cutter with its finegrade PCD tipped insert allows perfect surface state for contour milling on plastics. Delivered with an endcut you can also machine pockets.

/ Mit dem SAPHIR 205 Fräser erreicht man einen Oberflächenzustand auf den Flanken, der annähernd dem eines Naturdiamanten entspricht. Der Fräser erlaubt es Ihnen auf Kunststoffen wie PMMA ein anschließendes Polieren oder Beflammen zu reduzieren oder sogar zu vermeiden. Dieses Werkzeug verfügt über eine stirnseitige Schneide, um eine saubere Oberfläche zu erhalten.

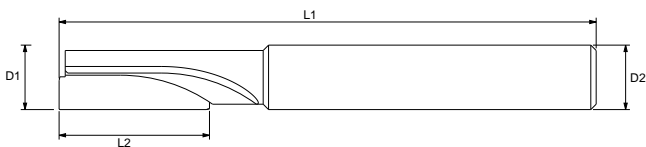

Cat-Nr 206000		Ø d1	Ø D2	L2	L1	z
Ref.	LMT- Code	mm	mm	mm	mm	
MÉTRIQUE						
2864846	206030	3	6	6	50	1
2825883	206040	4	6	10	50	1
2865165	206060	6	6	14	50	1
2868376	206080	8	8	18	50	1
2868381	206100	10	8	22	60	1
2868377	206120	12	8	22	60	1



CONSEILS D'EXPERTS

La fraise SAPHIR 206 permet d'obtenir des états de surface proche des résultats d'usinage au Diamant Naturel sur les flancs et dans les poches. Elle vous permettra aussi de réduire voir d'éliminer les opérations de flammage ou polissage sur les plastiques type PMMA.

/ The 206 SAPHIR milling cutter with its finegrade PCD tipped insert allows perfect surface state on plastics. Delivered with an endcut you can also machine pockets with an extreme good surface state.

/ Mit dem SAPHIR 206 Fräser erreicht man einen Oberflächenzustand an den Flanken und in Aussparungen, der annähernd dem eines Naturdiamanten entspricht. Damit kann das Polieren oder Beflammen von Kunststoffen Typ PMMA reduziert bzw. ganz weggelassen werden. Die stirnseitige Bearbeitung führt zur Herstellung von durchsichtigen Oberflächen an den Seiten und am Grund.

Cat-Nr 206000		Ø D1		Ø D2		L2		L1		z
Ref.	LMT- Code	mm	inch	mm	inch	mm	inch	mm	inch	
INCH										
2871934	206476	4,76	3/16"	6,35	1/4"	7,9	5/16"	76,2	3"	1
2871932	206635	6,35	1/4"	6,35	1/4"	15,87	5/8"	76,2	3"	1
2871935	206793	7,937	5/16"	9,52	3/8"	15,87	5/8"	76,2	3"	1
2871936	206952	9,52	3/8"	9,52	3/8"	15,87	5/8"	101,6	4"	1
2871937	206952A	9,52	3/8"	9,52	3/8"	28,57	1 1/8"	101,6	4"	1

Plastiques thermoformés

Thermo-moulded plastics | Thermoplaste

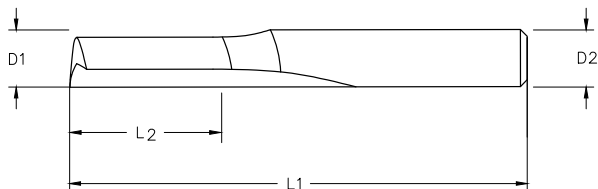

Cat-Nr 61-000		Ø D1	Ø D2	L2	L1	z
Ref.	LMT- Code	mm	mm	mm	mm	
MÉTRIQUE						
7054031	61-410	4	4	16	64	1
7054032	61-411	5	6	20	64	1
7054033	61-412	6	6	25	64	1
7054034	61-414	8	8	25	64	1
7054035	61-418	12	12	35	88	1



CONSEILS D'EXPERTS

Utilisables sur machine portable
/ Can be used with manual machine.
/ Tragbare Maschine

Cat-Nr 61-000		Ø D1		Ø D2		L2		L1		z
Ref.	LMT- Code	mm	inch	mm	inch	mm	inch	mm	inch	
INCH										
7054025	61-042	3,17	1/8"	6,35	1/4"	12,7	1/2"	50,8	2"	1
7054026	61-043	3,17	1/8"	6,35	1/4"	15,87	5/8"	102	4"	1
7054027	61-062	4,76	3/16"	6,35	1/4"	15,87	5/8"	50,8	2"	1
7054028	61-082	6,35	1/4"	6,35	1/4"	19,05	3/4"	63,5	2 1/2"	1
7054029	61-084	6,35	1/4"	6,35	1/4"	31,75	1 1/4"	102	4"	1
7054030	61-122	9,52	3/8"	9,52	3/8"	22,25	7/8"	63,5	2 1/2"	1

Plastiques, plastiques thermoformés, bois

Plastics, Thermosets plastics, wood / Thermoplaste, Holz

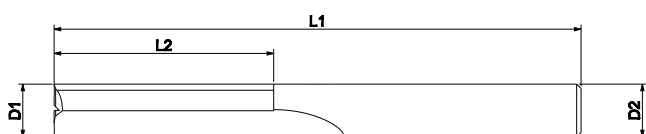

Cat-Nr 95 000		Ø D1	Ø D2	L2	L1	z
Ref.	LMT- Code	mm	mm	mm	mm	
MÉTRIQUE						
2749532	95209A	3	3	15	60	2
2749534	95209B	4	4	20	60	2
2749536	95209C	5	5	20	60	2
2722057	95209D	6	6	25	60	2
2749539	95209E	8	8	35	80	2

Plastiques, foam board, bois dur
 Plastic, foam board, hard wood | Kunststoff, Schaumstoff, Hartholz

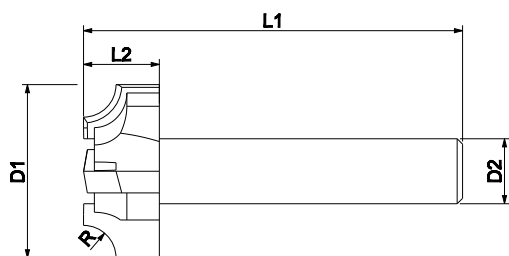

Concave
 Concave / Konkav

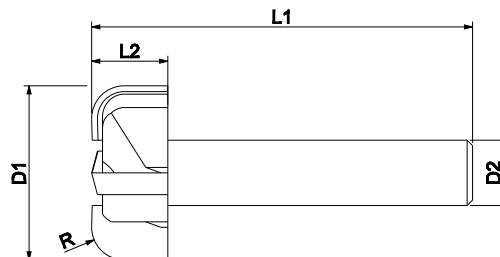

Convexe
 Convex / Konkav

Cat-Nr DE		Ø D1	Ø D2	L2	L1	R	z
Ref.	LMT-Code	mm	mm	mm	mm	mm	
MÉTRIQUE							
2702470	47110 Ø 10	10	6	7	35	1	4
2702599	47110 Ø 12	12	6	7	35	1	4
2702600	47110 Ø 16	16	6	7	35	1	4
2702601	47110 Ø 20	20	6	7	35	1	4
2702471	47115 Ø 10	10	6	7	35	1.5	4
2702482	47115 Ø 12	12	6	7	35	1.5	4
2702604	47115 Ø 16	16	6	7	35	1.5	4
2702605	47115 Ø 20	20	6	7	35	1.5	4
2702409	47120 Ø 10	10	6	7	35	2	4
2702467	47120 Ø 12	12	6	7	35	2	4
2825694	47120 Ø 16	16	6	7	35	2	4
2702469	47120 Ø 20	20	6	7	35	2	4
2702472	47125 Ø 10	10	6	7	35	2.5	4
2702606	47125 Ø 12	12	6	7	35	2.5	4
2702698	47125 Ø 16	16	6	7	35	2.5	4
2702608	47125 Ø 20	20	6	7	35	2.5	4
2702473	47130 Ø 10	10	6	7	35	3	4
2702609	47130 Ø 12	12	6	7	35	3	4
2702610	47130 Ø 16	16	6	7	35	3	4
2702611	47130 Ø 20	20	6	7	35	3	4

Cat-Nr DE		Ø D1	Ø D2	L2	L1	R	z
Ref.	LMT-Code	mm	mm	mm	mm	mm	
MÉTRIQUE							
2702474	48105 Ø 10	10	6	7	35	0.5	4
2702612	48105 Ø 12	12	6	7	35	0.5	4
2702613	48105 Ø 16	16	6	7	35	0.5	4
2702614	48105 Ø 20	20	6	7	35	0.5	4
2702475	48110 Ø 10	10	6	7	35	1	4
2702615	48110 Ø 12	12	6	7	35	1	4
2702616	48110 Ø 16	16	6	7	35	1	4
2702617	48110 Ø 20	20	6	7	35	1	4
2702476	48115 Ø 10	10	6	7	35	1.5	4
2702618	48115 Ø 12	12	6	7	35	1.5	4
2702619	48115 Ø 16	16	6	7	35	1.5	4
2702620	48115 Ø 20	20	6	7	35	1.5	4
2702477	48120 Ø 10	10	6	7	35	2	4
2702621	48120 Ø 12	12	6	7	35	2	4
2702622	48120 Ø 16	16	6	7	35	2	4
2702623	48120 Ø 20	20	6	7	35	2	4
2702478	48125 Ø 10	10	6	7	35	2.5	4
2702624	48125 Ø 12	12	6	7	35	2.5	4
2702625	48125 Ø 16	16	6	7	35	2.5	4
2702626	48125 Ø 20	20	6	7	35	2.5	4
2702479	48130 Ø 10	10	6	7	35	3	4
2702627	48130 Ø 12	12	6	7	35	3	4
2702628	48130 Ø 16	16	6	7	35	3	4
2702629	48130 Ø 20	20	6	7	35	3	4
2702630	48140 Ø 12	12	6	7	35	4	4
2702631	48140 Ø 16	16	6	7	35	4	4
2702632	48140 Ø 20	20	6	7	35	4	4
2702634	48150 Ø 16	16	6	7	35	5	4
2702633	48150 Ø 20	20	6	7	35	5	4

Plastiques, foam board, bois dur
 Plastic, foam board, hard wood | Kunststoff, Schaumstoff, Hartholz

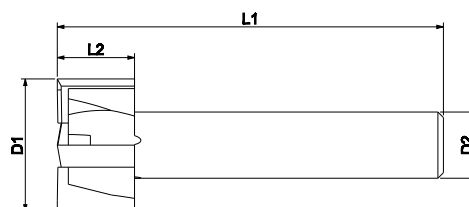
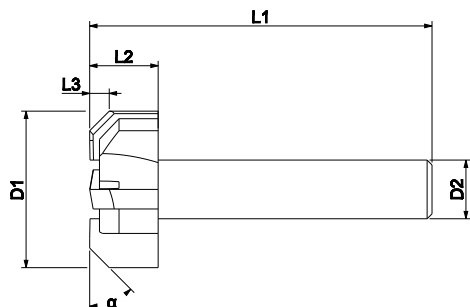

Angle
 Angle / Winkel

Cat-Nr DE		Ø D1	Ø D2	L2	L3	L1	α	z
Ref.	LMT-Code	mm	mm	mm	mm	mm	mm	
MÉTRIQUE								
2702381	45130 Ø 10	10	6	7	1,7	35	30	4
2702384	45130 Ø 12	12	6	7	1,7	35	30	4
2702387	45130 Ø 16	16	6	7	1,7	35	30	4
2702390	45130 Ø 20	20	6	7	1,7	35	30	4
2702380	45145 Ø 10	10	6	7	2	35	45	4
2702383	45145 Ø 12	12	6	7	2	35	45	4
2702386	45145 Ø 16	16	6	7	2	35	45	4
2709587	45145 Ø 20	20	6	7	2	35	45	4
2702379	45160 Ø 10	10	6	7	2	35	60	4
2702382	45160 Ø 12	12	6	7	2	35	60	4
2702385	45160 Ø 16	16	6	7	2	35	60	4
2702388	45160 Ø 20	20	6	7	2	35	60	4
2702363	45170 Ø 10	10	6	7	3	35	70	4
2702354	45170 Ø 12	12	6	7	3	35	70	4
2702365	45170 Ø 16	16	6	7	3	35	70	4
2702366	45170 Ø 20	20	6	7	3	35	70	4
2702353	45180 Ø 10	10	6	7	4	35	80	4
2702364	45180 Ø 12	12	6	7	4	35	80	4
2702355	45180 Ø 16	16	6	7	4	35	80	4
2702356	45180 Ø 20	20	6	7	4	35	80	4

Cat-Nr DE		Ø D1	Ø D2	L2	L1	α	z
Ref.	LMT-Code	mm	mm	mm	mm	mm	
MÉTRIQUE							
2702160	45190 Ø 10	10	6	7	35	90	4
2702198	45190 Ø 12	12	6	7	35	90	4
2702199	45190 Ø 16	16	6	7	35	90	4
2702200	45190 Ø 20	20	6	7	35	90	4

Fraises à surfer
 Face milling cutter | Fräser zum Planfräsen

 **Plastiques, bois, non ferreux**
 Plastic, wood, non-ferrous metals | Kunststoff, Holz, Nichteisenmetalle



Cat-Nr DEPCD		Ø D1	Ø D2	L2	L1	z
Ref.	LMT-Code	mm	mm	mm	mm	
2709462	98105	16	6	6	36	4



CONSEILS D'EXPERTS

Avantage du PCD: très longue durée de vie
 / PCD advantage: very long tool life
 / Vorteil des PKD: hohe Standzeit

Fraises à surfer PCD avec rayon
 PCD Face milling cutter with radius | PKD Fräser zum Planfräsen mit Radius

 **Plastiques, bois, non ferreux**
 Plastic, wood, non-ferrous metals | Kunststoff, Holz, Nichteisenmetalle

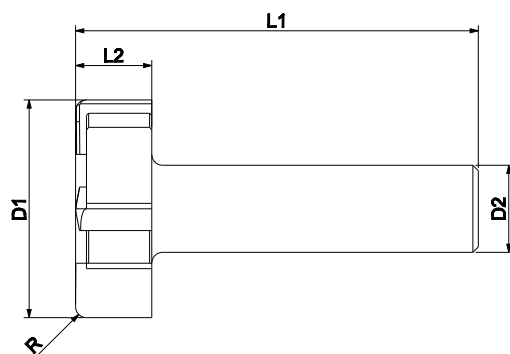

CONSEILS D'EXPERTS

Avantage du PCD:
 - très longue durée de vie
 - amélioration des états de surface
 / PCD advantages:
 - very long tool life
 - best surface state
 / Vorteile des PKD:
 - h here Standzeit
 - bessere Oberfläche

Cat-Nr DEPCDR		Ø D1	Ø D2	L2	L1	R	z
Ref.	LMT-Code	mm	mm	mm	mm	mm	
2704724	91176	10	6	6	35	0,5	2
2709460	98103	10	6	6	34	1	2
2709461	98104	10	6	6	35	2	2
2704723	97251	20	8	7	37	1	4

En tant que spécialiste dans le développement et la fabrication d'outils coupants de précision, LMT propose de développer des solutions d'usinage sur mesure pour vos applications. Fraises décolletées, rayonnées, matériaux spécifiques, opérations d'ébauche et/ou de finition, ...

Nos techniciens sont à votre écoute pour vous aider à définir des solutions qui vous permettront par exemple de :

- améliorer les états de surface de vos pièces,
- réduire vos coûts outils/pièces par l'utilisation d'outils PCD ou revêtus ou à géométrie spéciale,
- supprimer des étapes dans vos processus de fabrication,



As precision cutting tools manufacturer LMT offers to develop tailor-made solutions for your applications. Necked mills, special radius, special materials to machine, roughing or/and finishing operations, ...

Our technicians can help you with the definition of a tooling solution that can allow you to :

- Improve surface state of workpieces,
- Decrease your tool cost per piece by using special geometries or coated or PCD tipped tools,
- Cut steps in your manufacturing processes

Als Schneidwerkzeugspezialist bietet LMT Sonderleistungen für Ihre Anwendungen. Freigeschliffene Fräser, Radiusfräser, Sonderwerkstoffe, Schrupp – oder Fertigbearbeitung

Unsere Anwendungstechniker helfen Ihnen Werkzeuglösungen zu finden für :

- Verbesserung der Oberflächengüte
- Reduzierung der Werkzeugkosten bei Verwendung einer Sondergeometrie, beschichtete Werkzeuge oder PKD bestückte Werkzeuge
- Einsparung von Bearbeitungsprozessen



Remplir le formulaire et l'envoyer à :

Please fill in the form and send at | Formular ausfüllen und senden an :

E-Mail : service.client@lmt-belin.com

Fax : +33 (0) 474 758 989

Information Client | Customer information | Kundenangaben

Société Company / Firma		Contact Contact person Ansprechpartner	
Adresse Address / Adresse		Téléphone Phone / Telefon	
		E-Mail E-Mail / E-Mail	

Pièce à usiner | Workpiece information | Werkstückangaben

Matière Material to be machined / Zu bearb. Werkstoff		Largeur de coupe (a_e) Width of cut (a _e) / Seitliche Zustellung (a _e)	
Opération à réaliser Machining operation / Bearbeitungsart		Profondeur de coupe (a_p) Depth of cut / Schnitttiefe (a _p)	

Machine | Machine | Maschine

Type Machine type / Maschinentyp		Attachement de la pièce Workpiece clamping / Werkstückspannung	
Position d'usinage Treatment position / Bearbeitungslage	<input type="checkbox"/> horizontale <input type="checkbox"/> verticale horizontal vertical horizontal vertikal	Information complément. Additional information / Zusatzangaben	
Vitesse max. broche (RPM) Max. spindle speed (RPM) / Max. Drehzahl (min-1)			

Côte d'outil | Tool data | Werkzeugangaben

Quantité Quantity / Stückzahl		Nombre de dents Number of teeth / Schneidenzahl	
Revêtement Coating / Beschichtung		Type de queue Shank style / Schaftausführung	
Hélice Helix / Drall	<input type="checkbox"/> droite <input type="checkbox"/> gauche <input type="checkbox"/> droite right left straight rechts links gerade	Outil similaire à Tool similar to / Werkzeug ähnlich	
Coupe en bout ? Center cutting? / Über Mitte schneidend?	<input type="checkbox"/> oui <input type="checkbox"/> non yes no ya nein		

Information complément. General information / Allgemeine Informationen	<p> Diamètre de coupe Cutting dia. Schneiden Ø [] </p> <p> Long. de dent Flute length Schneidnlänge [] </p> <p> Rayon d'angle Corner radius Eckenradius [] </p> <p> Diamètre décollé Neck dia. Hals Ø [] </p> <p> Longueur décollé Neck length Halslänge [] </p> <p> Longueur totale Over all length / Gesamtlänge [] </p> <p> Diamètre de la queue Shank dia. Schaft Ø [] </p>
---	---

Fraisage de forme

Form milling
Formfräser

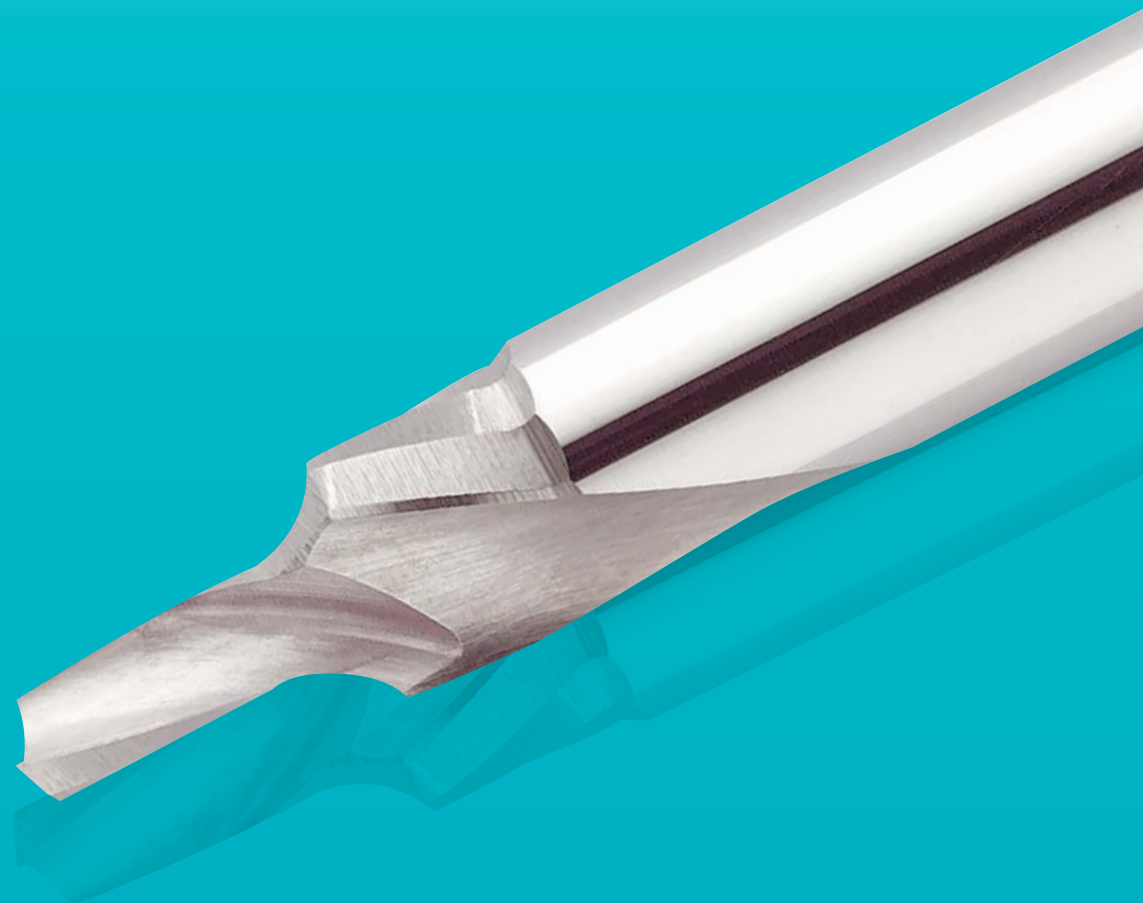

Plastiques, foam board, bois, résine
Plastic, foam board, wood, resin | Kunststoff, Schaumstoff, Holz, Harz

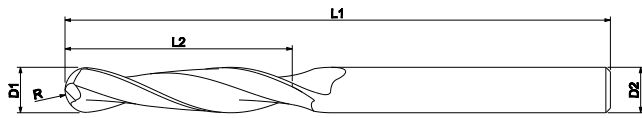

Cat-Nr 117 000		Ø D1	Ø D2	L2	L1	R	z	
Ref.	LMT-Code	mm	mm	mm	mm	mm		
MÉTRIQUE								
Longue / Long / gross								
2700334	117030	3	6	15	90	1,5	2	
2700335	117040	4	6	20	100	2	2	
2700336	117050	5	6	20	100	2,5	2	
2700337	117060	6	6	30	130	3	2	
2700340	117080	8	8	40	150	4	2	
2700338	117100	10	10	50	180	5	2	
2700339	117120	12	12	50	200	6	2	
Courtes / short / klein								
7053992	52-240BM	3	6	12	50	1,5	2	
7053993	52-280BM	6	6	22	64	3	2	
7053994	52-320BM	10	10	29	76	5	2	
7053995	52-360BM	12	12	29	76	6	2	



CONSEILS D'EXPERTS

Développée pour des opérations de gravure et de modelage, avec une géométrie permettant une meilleure découpe par rapport à la majorité des fraises à bout hémisphérique

/ Designed for carving and modeling operations. Their improved geometry gives a superior cut compared to most ball nose end mills

/ Speziell für das Form- und Kopierfräsen. Die verbesserte Geometrie ermöglicht einen verbesserten Schnitt im Vergleich zu herkömmlichen Kugelfräsern

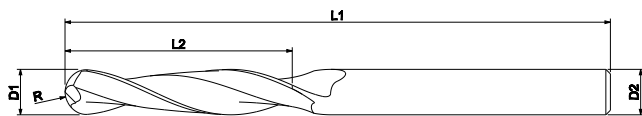

Cat-Nr 52-000		Ø D1		Ø D2		L2		L1		R	z	
Ref.	LMT-Code	mm	inch	mm	inch	mm	inch	mm	inch	mm	inch	
INCH												
Courtes / short / klein												
7053996	52-235B	1,58	1/16"	3,17	1/8"	6,35	1/4"	50,8	2	0,79	1/32"	2
7053997	52-244B	3,17	1/8"	3,17	1/8"	12,7	1/2"	50,8	2	1,59	1/16"	2
7053998	52-240B	3,17	1/8"	6,35	1/4"	12,7	1/2"	50,8	2	1,59	1/16"	2
7053999	52-260B	4,76	3/16"	6,35	1/4"	19,05	3/4"	50,8	2	2,38	3/32"	2
7054000	52-280B	6,35	1/4"	6,35	1/4"	22,25	7/8"	63,5	2 1/2"	3,18	1/8"	2
7054001	52-320B	9,52	3/8"	9,52	3/8"	28,5	1 1/8"	76,2	3	4,76	3/16"	2
7054002	52-360B	12,7	1/2"	12,7	1/2"	28,5	1 1/8"	76,2	3	6,35	1/4"	2
7054003	52-386B	15,87	5/8"	15,87	5/8"	57,15	2 1/4"	102	4	7,94	5/16"	2
7054004	52-397B	19,05	3/4"	19,05	3/4"	63,5	2 1/2"	127	5	9,53	3/8"	2

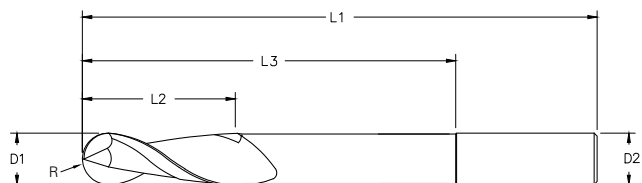

Cat-Nr 52-000		Ø D1		Ø D2		L2		L3		L1		R	z	
Ref.	LMT-Code	mm	inch	mm	inch	mm	inch	mm	inch	mm	inch	mm	inch	
INCH														
Longue / Long / gross														
7054005	52-235BL	1,58	1/16"	3,17	1/8"	6,35	1/4"	-	-	76,2	3	0,79	1/32"	2
7054006	52-244BL	3,17	1/8"	3,17	1/8"	12,7	1/2"	41,28	1 5/8"	76,2	3	1,59	1/16"	2
7054007	52-240BL	3,17	1/8"	6,35	1/4"	12,7	1/2"	41,28	1 5/8"	76,2	3	1,59	1/16"	2
7054008	52-260BL	4,76	3/16"	6,35	1/4"	19,05	3/4"	41,28	1 5/8"	76,2	3	2,38	3/32"	2
7054009	52-280BL	6,35	1/4"	6,35	1/4"	25,4	1	66,68	2 5/8"	102	4	3,18	1/8"	2
7054010	52-320BL	9,52	3/8"	9,52	3/8"	31,75	1 1/4"	66,68	2 5/8"	102	4	4,76	3/16"	2
7054011	52-360BL	12,7	1/2"	12,7	1/2"	38,1	1 1/2"	92,08	3 5/8"	127	5	6,35	1/4"	2
7054012	52-386BL	15,87	5/8"	15,87	5/8"	63,5	2 1/2"	92,08	3 5/8"	127	5	7,94	5/16"	2
7054013	52-397BL	19,05	3/4"	19,05	3/4"	76,2	3	117,48	4 5/8"	152,4	6	9,53	3/8"	2



Plastiques, foam board, bois, résine
Plastic, foam board, wood, resin | Kunststoff, Schaumstoff, Holz, Harz

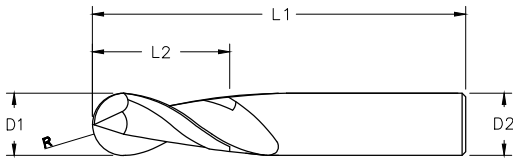

Cat-Nr 65-200		Ø D1	Ø D2	L2	L1	R	z
Ref.	LMT-Code	mm	mm	mm	mm	mm	
MÉTRIQUE							
7053979	65-280B	3	3	12	64	1,5	2
7053980	65-285B	6	6	20	76	3	2
7053981	65-290B	8	8	25	76	4	2
7053982	65-295B	10	10	30	76	5	2



Cat-Nr 65-200		Ø D1		Ø D2		L2		L1		R	z	
Ref.	LMT-Code	mm	inch	mm	inch	mm	inch	mm	inch	mm	inch	
INCH												
7053983	65-205B	1,58	1/16"	3,17	1/8"	6,35	1/4"	50,8	2	0,79	1/32"	2
7053984	65-210B	3,17	1/8"	3,17	1/8"	12,7	1/2"	63,5	2 1/2"	1,58	1/16"	2
7053985	65-215B	4,76	3/16"	6,35	1/4"	12,7	1/2"	63,5	2 1/2"	2,38	3/32"	2
7053986	65-220B	6,35	1/4"	6,35	1/4"	12,7	1/2"	63,5	2 1/2"	3,17	1/8"	2
7053987	65-225B	6,35	1/4"	6,35	1/4"	28,5	1 1/8"	76,2	3	3,17	1/8"	2
7053988	65-235B	7,95	5/16"	7,95	5/16"	12,7	1/2"	76,2	3	3,975	5/32"	2
7053989	65-240B	7,95	5/16"	7,95	5/16"	28,5	1 1/8"	76,2	3	3,975	5/32"	2
7053990	65-250B	9,52	3/8"	9,52	3/8"	28,5	1 1/8"	76,2	3	4,76	3/16"	2
7053991	65-260B	12,7	1/2"	12,7	1/2"	28,5	1 1/8"	76,2	3	6,35	1/4"	2



CONSEILS D'EXPERTS

La géométrie novatrice de cet outil lui octroie la capacité d'obtenir des états de surface de Ra 0,7 dans des plastiques qualifiés de « techniques » (ex : prothèses médicales) en supprimant les surfaces irrégulières ou marques éventuelles de l'outil sur la pièce.

/ The new tool's geometry, specially designed point, and highly polished primary clearance and flute give the tool the ability to attain a surface quality of 28 Ra (inch) in mechanical plastic (e. g. inlays for kneeprothesis), avoiding irregular surface finish or evident tool marks.

/ Die Werkzeuggeometrie mit einer speziellen Kugelform, poliertem Freiwinkel und polierter Spannkammer erlauben es, mit diesem Werkzeug Oberflächengüten von Ra 0,7 (metrisch) ohne sichtbare Bearbeitungsmarken in technischen Kunststoffen (z. B. Inlays für Knieprothesen) zu erzeugen.

Plastiques, foam board, bois

Plastic, foam board, wood | Kunststoff, Schaumstoff, Holz

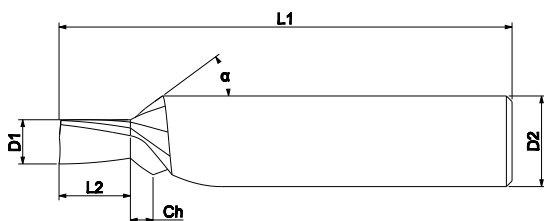

Cat-Nr EDC		Ø D1	Ø D2	L2	L1	Ch	α	z
Ref.	LMT- Code	mm	mm	mm	mm	mm	°	
MÉTRIQUE								
2725238	99058	4	8	4.3	40	2	45°	1
2739327	00191	4	8	6.3	40	2	45°	1

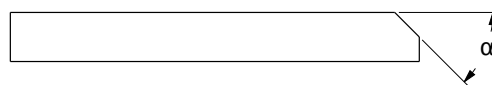

Cat-Nr EDC		Ø D1		Ø D2		L2		L1		Ch		α	z
Ref.	LMT- Code	mm	inch	mm	inch	mm	inch	mm	inch	mm	inch	°	
INCH													
2739331	00192	4.76	3/16"	9.52	3/8"	4.3	0.169"	50.8	2"	2.38	0.094"	45°	1
2739333	00193	4.76	3/16"	9.52	3/8"	6.3	0.248"	50.8	2"	2.38	0.094"	45°	1

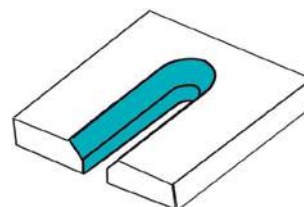

N'hésitez pas à nous consulter pour des dimensions différentes

Do not hesitate to contact us for customized dimensions

Zur Auskunft bezüglich kundenspezifischer Dimension, wenden Sie sich an uns

Plastiques, foam board, bois

Plastic, foam board, wood | Kunststoff, Schaumstoff, Holz

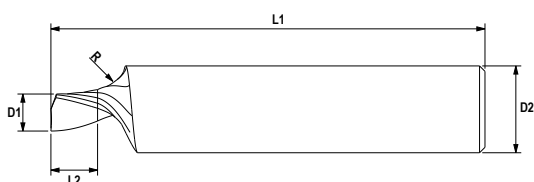

Cat-Nr EDR		Ø D1	Ø D2	L2	L1	R	z
Ref.	LMT- Code	mm	mm	mm	mm	mm	
MÉTRIQUE							
2739439	00194	4	8	4,3	40	2	1
2739441	00195	4	8	6,3	40	2	1



Cat-Nr EDR		Ø D1		Ø D2		L2		L1		R		z
Ref.	LMT- Code	mm	inch	mm	inch	mm	inch	mm	inch	mm	inch	
INCH												
2739443	00196	4,76	3/16"	9,52	3/8"	4,3	0,169"	50,8	2"	2,38	0,094"	1
2739445	00197	4,76	3/16"	9,52	3/8"	6,3	0,248"	50,8	2"	2,38	0,094"	1

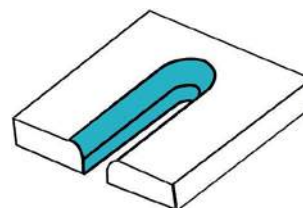

N'hésitez pas à nous consulter pour des dimensions différentes

Do not hesitate to contact us for customized dimensions

Zur Auskunft bezüglich kundenspezifischer Dimension, wenden Sie sich an uns

Métaux non-ferreux

Special for non-ferrous metals | Speziell für Nichteisenwerkstoffe

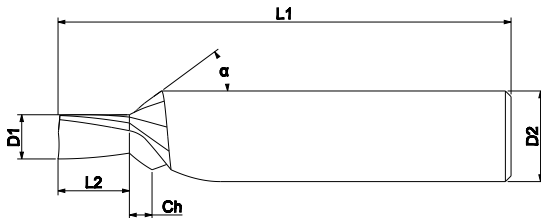

Cat-Nr EDAC		Ø D1	Ø D2	L2	L1	Ch	α	z
Ref.	LMT-Code	mm	mm	mm	mm	mm	°	
MÉTRIQUE								
2730645	99203	4	6	2,3	40	1	45°	1
2739335	00198	4	6	3,3	40	1	45°	1



Cat-Nr EDAC		Ø D1		Ø D2		L2		L1		Ch		α	z
Ref.	LMT-Code	mm	inch	mm	inch	mm	inch	mm	inch	mm	inch	°	
INCH													
2739343	00199	4,76	3/16"	6,35	1/4"	2,3	0,091	50,8	2"	1	0,031	45°	1
2739345	00200	4,76	3/16"	6,35	1/4"	3,3	0,130	50,8	2"	1	0,031	45°	1

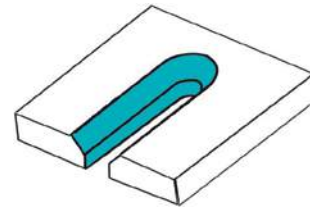

N'hésitez pas à nous consulter pour des dimensions différentes

Do not hesitate to contact us for customized dimensions

Zur Auskunft bezüglich kundenspezifischer Dimension, wenden Sie sich an uns

Métaux non-ferreux

Special for non-ferrous metals | Speziell für Nichteisenwerkstoffe

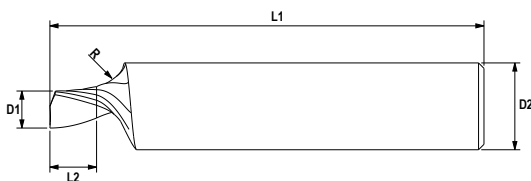

Cat-Nr EDAR		Ø D1	Ø D2	L2	L1	R	z
Ref.	LMT-Code	mm	mm	mm	mm	mm	
MÉTRIQUE							
2739431	00201	4	6	2,3	40	1	1
2739433	00202	4	6	3,3	40	1	1

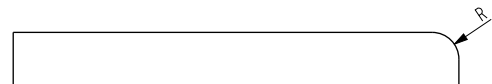

Cat-Nr EDAR		Ø D1		Ø D2		L2		L1		R		z
Ref.	LMT-Code	mm	inch	mm	inch	mm	inch	mm	inch	mm	inch	
INCH												
2739435	00203	4,76	3/16"	6,35	1/4"	2,3	0,091	50,8	2"	1	0,039	1
2739437	00204	4,76	3/16"	6,35	1/4"	3,3	0,130	50,8	2"	1	0,039	1

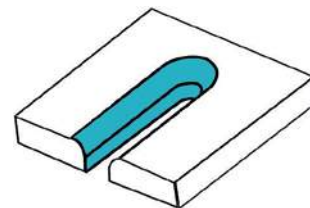

N'hésitez pas à nous consulter pour des dimensions différentes

Do not hesitate to contact us for customized dimensions

Zur Auskunft bezüglich kundenspezifischer Dimension, wenden Sie sich an uns

Plastiques, foam board, bois dur

Plastic, foam board, hard wood | Kunststoff, Schaumstoff, Hartholz

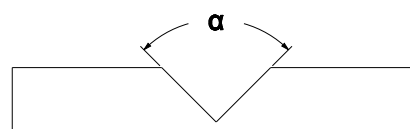
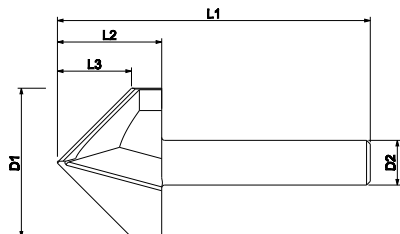

Cat-Nr NPR		Ø D1	Ø D2	L2	L3	L1	α	z
Ref.	LMT-Code	mm	mm	mm	mm	mm	°	
MÉTRIQUE								
2702990	80039	20	6	20,5	17,3	48	60°	2
2702401	77310	20	6	14	10	42	90°	2
2702420	77311	20	6	12,4	8,4	40	100°	2
2702421	77312	20	6	11	7	39	110°	2
2702422	77313	20	6	9,8	5,8	38	120°	2
2702423	77314	20	6	8,7	4,7	37	130°	2
2702424	77315	20	6	9	4	37	140°	2
2702425	77316	20	6	6,6	2,6	34	150°	2
2702426	77317	20	6	5,8	1,8	34	160°	2

Plastiques tendres, nylon, bois tendre

Soft plastics, nylon, soft wood | Weicher Kunststoff Nylon, weiches Holz

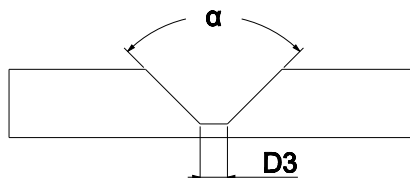
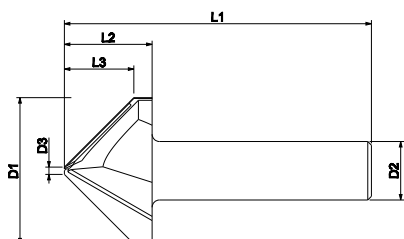

Cat-Nr NPRC		Ø D1	Ø D2	Ø D3	L2	L3	L1	α	z
Ref.	LMT-Code	mm	mm	mm	mm	mm	mm	°	
MÉTRIQUE									
2730661	99162	32	8	0,5	32	27,7	62	60°	2
2730663	99163	32	8	0,5	20	16	50	90°	2
2747409	02013	32	8	0,5	17	13,4	46	100°	2
2747411	02014	32	8	0,5	14	11,2	44	110°	2
2747413	02015	32	8	0,5	12	9,2	42	120°	2
2730665	99164	32	8	0,5	10	5,8	40	140°	2

Cat-Nr NPRC		Ø D1	Ø D2		Ø D3		L2		L3		L1		α	z
Ref.	LMT-Code	mm	mm	inch	mm	inch	mm	inch	mm	inch	mm	inch	°	
INCH														
2730655	99159	31,75	9,52	3/8"	0,5	0,02	32	1,26"	27	1,06"	62	2,44	60°	2
2730657	99160	31,75	9,52	3/8"	0,5	0,02	20	0,787"	15,6	0,614"	50	1,97	90°	2
2730659	99161	31,75	9,52	3/8"	0,5	0,02	10	0,394"	5,7	0,224"	40	1,57	140°	2

Plastiques, foam board, bois dur
 Plastic, foam board, hard wood | Kunststoff, Schaumstoff, Hartholz

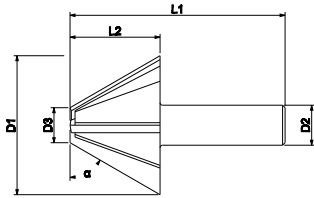

Cat-Nr IED		Ø D1	Ø D2	Ø D3	L2	L1	α	z
Ref.	LMT-Code	mm	mm	mm	mm	mm	°	
MÉTRIQUE								
2702347	77036	13,35	8	7	18	43	80°	4
2702346	77037	15	8	7	18	43	77°30'	4
2702345	77038	16,65	8	7	18	43	75°	4
2702344	77039	18,35	8	7	18	43	72°30'	4
2702343	77040	20,1	8	7	18	43	70°	4
2702342	77041	21,9	8	7	18	43	67°30'	4
2702341	77042	23,8	8	7	18	43	65°	4
2702340	77043	25,75	8	7	18	43	62°30'	4
2702339	77044	27,8	8	7	18	43	60°	4
2702337	91095	30,5	8	7	14	39	50°	4
2702336	91094	31	8	7	12	37	45°	4

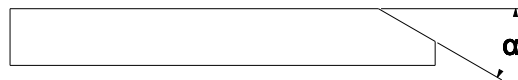

Fraise conique plaquettes PCD brasées
 Conical cutter PCD tipped | Konischerfräser mit gelöteten PKD Platten

Plastiques, bois, non ferreux
 Plastic, wood, non-ferrous metals | Kunststoff, Holz,

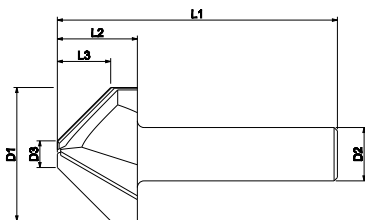

PCD

Cat-Nr NPRPCD		Ø D1	Ø D2	Ø D3	L2	L3	L1	α	z
Ref.	LMT-Code	mm	mm	mm	mm	mm	mm	°	
MÉTRIQUE									
2829770	NPRPCD	20	8	4	12	8	42	90°	2

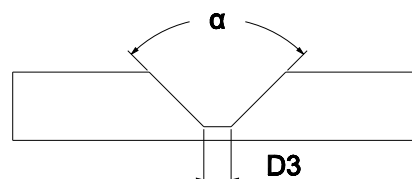

Alucobond et métaux non ferreux

Alucobond and non-ferrous metals | Alucobond und Nichteisenwerkstoffe

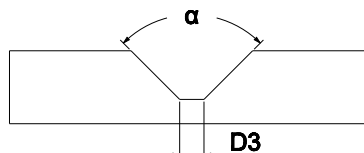
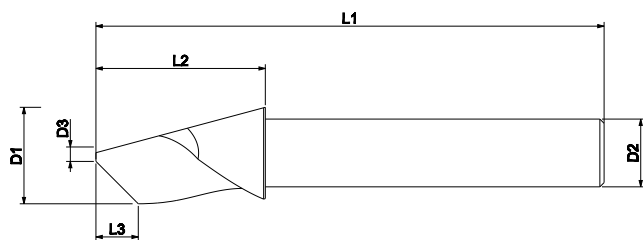

Cat-Nr PLIH	Ø D1	Ø D2	Ø D3	L2	L3	L1	α	z	
Ref.	LMT-Code	mm	mm	mm	mm	mm	°		
2874112	PLIH060A	6	6	0,3	-	2,9	60	90	1
2872630	PLIH060B	6	6	0,5	-	2,8	60	90	1
2874113	PLIH080A	8	8	0,3	-	3,9	60	90	1
2874111	PLIH080B	8	8	0,5	-	3,8	60	90	1
2872631	PLIH100A	10	6	2	40	4,0	60	90	1
2874114	PLIH100B	10	8	0,3	40	4,9	60	90	1
2874115	PLIH100C	10	10	0,5	-	4,8	60	90	1
2874116	PLIH120A	12	8	0,3	40	5,9	60	90	1
2874117	PLIH120B	12	8	2	40	5,0	60	90	1
2874118	PLIH120C	12	10	0,5	40	5,8	60	90	1



CONSEILS D'EXPERTS

Grâce à une nouvelle géométrie spécialement développée cette fraise vous permettra de réaliser des rainures chanfreinées à 90° dans les matériaux type alucobond et métaux non-ferreux

/ Thanks to a new geometry especially developed for milling operations of chamfered grooves. For alucobond and non-ferrous metals

/ Dank einer neuen Geometrie die speziell für diesen Fräser entwickelt wurde, kann man 90° abgekantete Nuten erzeugen. Dieses sowohl für Alucobond, als auch für Nichteisenwerkstoffe.

Plastiques

Plastics | Kunststoff

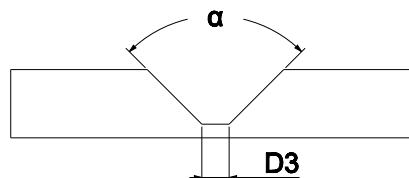
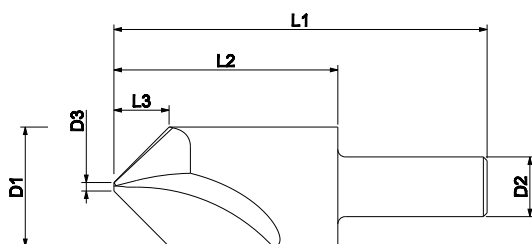

Cat-Nr PLI	Ø D1	Ø D2	Ø D3	L2	L3	L1	α	z	
Ref.	LMT-Code	mm	mm	mm	mm	mm	°		
2830895	31014007	8	8	0,2	-	9,4	50	45	2
2830894	31014006	16	8	0,2	30	19	50	45	2
2702157	91106	8	8	0,2	-	3,9	50	90	2
2702156	91105	12	12	0,2	-	5,9	50	90	2
2702158	96188	16	8	0,2	30	7,9	50	90	2
2739405	00209	16	8	0,5	30	7,75	50	90	2
2739403	00210	16	8	1	30	7,5	50	90	2

 Alucobond

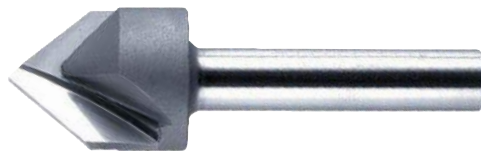
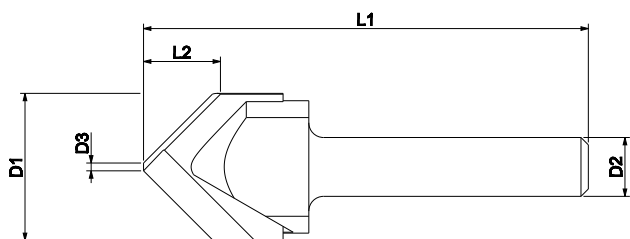

Cat-Nr FCOB		Ø D1	Ø D2	Ø D3	L2	L1	α	z
Ref.	LMT-Code	mm	mm	mm	mm	mm	°	
MÉTRIQUE								
2730666	99165	20	8	3	8,5	60	90	2
2730668	99166	20	8	2	3,7	60	135	2

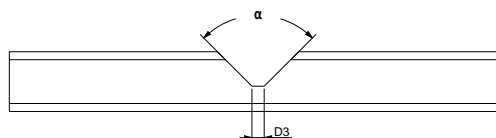

Cat-Nr FCOB		Ø D1		Ø D2		Ø D3		L2		L1		α	z
Ref.	LMT-Code	mm	inch	mm	inch	mm	inch	mm	inch	mm	inch	°	
INCH													
2730672	99167	19,05	3/4"	9,52	3/8"	3	0,118	8	0,315	60	2,352	90	2
2730674	99168	19,05	3/4"	9,52	3/8"	2	0,078	3,6	0,142	60	2,352	135	2
2749541	99167A	19,05	3/4"	9,52	3/8"	2	0,078	6,2	0,244	60	2,352	108	2

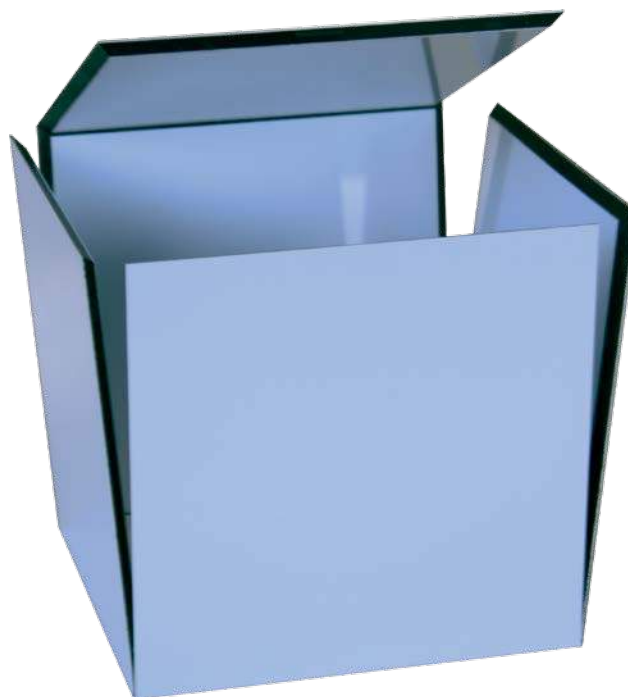
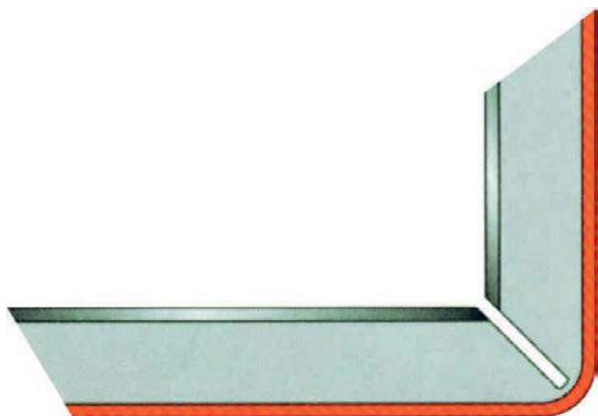

Plastiques, foam board, bois dur
Plastic, foam board, hard wood | Kunststoff, Schaumstoff, Hartholz

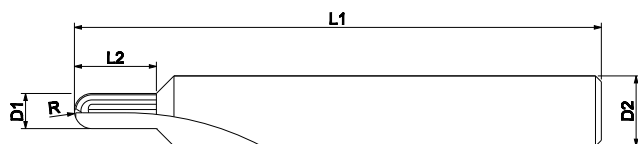

Cat-Nr DR	Ø D1	Ø D2	L2	L1	R	z	
Ref.	LMT-Code	MÉTRIQUE					
2702215	96186	1	6	3	45	0,5	2
2702214	96185	1,5	6	3	45	0,75	2
2702213	78085	2	6	3	45	1	2
2702212	96085	2,5	6	7	45	1,25	2
2702211	77358	3	6	7	45	1,5	2
2702210	77357	4	6	7	45	2	2
2702209	77356	5	6	7	45	2,5	2
2702161	77355	6	6	7	45	3	2

Fraises bout sphérique plaquettes carbure brasées DR
Carbide tipped spherical cutters DR / DR Kugelfräser mit gelöteten HM Platten

Plastiques, foam board, bois dur
Plastic, foam board, hard wood | Kunststoff, Schaumstoff, Hartholz

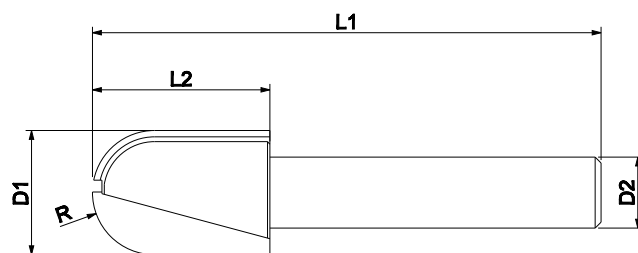

Cat-Nr DR	Ø D1	Ø D2	L2	L1	R	z	
Ref.	LMT-Code	MÉTRIQUE					
2702480	77354	7	6	7	45	3,5	2
2702229	77353	8	6	10	40	4	2
2702446	77352	8,5	6	10	38	4,25	2
2702445	76462	9	6	10	38	4,5	2
2702444	77351	9,5	6	10	38	4,75	2
2702443	73584	10	6	15	43	5	2
2702442	73585	10,5	6	15	43	5,25	2
2702441	72528	11	8	15	40	5,5	2
2702440	73479	11,5	8	15	40	5,75	2
2702439	72527	12	8	15	40	6	2
2702438	73478	12,5	8	15	40	6,25	2
2702437	72526	13	8	15	40	6,5	2
2702436	73477	13,5	8	15	40	6,75	2
2702203	72525	14	8	15	40	7	2
2702435	73476	14,5	8	15	40	7,25	2

Cat-Nr DR	Ø D1	Ø D2	L2	L1	R	z	
Ref.	LMT-Code	MÉTRIQUE					
2702434	72524	15	8	15	40	7,5	2
2702433	73475	15,5	8	15	40	7,75	2
2702432	73505	16	8	15	40	8	2
2702457	73474	16,5	8	15	40	8,25	2
2702456	73470	17	8	15	40	8,5	2
2702455	73473	17,5	8	15	40	8,75	2
2702454	73506	18	8	15	40	9	2
2702453	73472	18,5	8	15	40	9,25	2
2702452	73471	19	8	15	40	9,5	2
2702451	68415	20	8	15	40	10	2
2702450	71515	22	8	16	41	11	2
2702449	68416	24	8	15	40	12	2
2702448	71516	26	8	18	43	13	2
2702447	75349	28	8	15	40	14	2



Plastiques, foam board, bois dur

Plastic, foam board, hard wood | Kunststoff, Schaumstoff, Hartholz

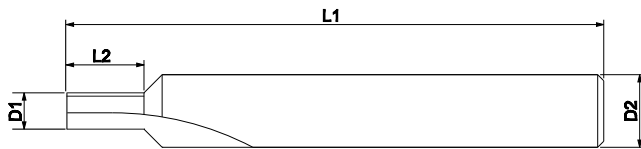

Cat-Nr P		Ø D1	Ø D2	L2	L1	z
Ref.	LMT-Code	mm	mm	mm	mm	
MÉTRIQUE						
2702162	19020	2	6	3	40	2
2702216	19025	2.5	6	3	40	2
2702217	19030	3	6	3	40	2
2702218	19035	3.5	6	4	40	2
2702219	19040	4	6	4	40	2
2702219	19045	4.5	6	4	40	2
2702221	19050	5	6	4	40	2
2702222	19055	5.5	6	4	40	2
2702223	19060	6	6	4	40	2
2702225	19080	8	6	9	45	2

Gravage

Engraving
Gravur



Plastiques et métaux non ferreux
Plastics and non-ferrous metals | Kunststoff und Nichteisenmetalle

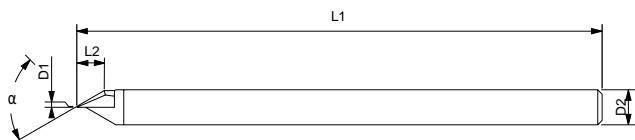

PCD

Cat-Nr: 212000	Ø D1	Ø D2	L2	L1	α	z	
Ref.	LMT-Code	MÉTRIQUE					
2825591	212090	0,1	4	3,9	60	90	1
2821644	212060	0,2	4	3,8	60	60	1



CONSEILS D'EXPERTS

Ces fraises de gravage super finition à plaquettes PCD vous permettront d'obtenir des états de surface proche des résultats d'usinage au Diamant Naturel avec une longue durée de vie.

/ The superfinish PCD tipped engraving mills allow you to machine plastics and non-ferrous metals with a very clear surface state (close to natural diamond machining results) with an increased tool life.

/ Die PKD best ckten Gravierfr ser erreichen eine nahezu genauso gute Oberfl cheng te wie die eines Naturdiamantr fr sers . Standzeit und Performance bertreffen bei weitem die Erwartungen.

N'hésitez pas à nous consulter pour des dimensions différentes.

Do not hesitate to contact us for customized dimensions.

Zur Auskunft bezüglich kundenspezifischer Dimension, wenden Sie sich an uns.







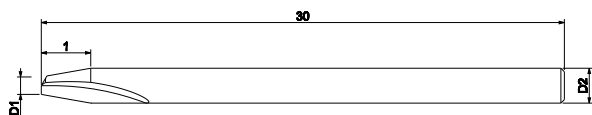

Plastiques, bois, non ferreux

Plastic, wood, non-ferrous metals | Kunststoff, Holz, Nichteisenwerkstoffe



Cat-Nr FI	D1 mm	D2 mm	   				
Ref.	LMT-Code	MÉTRIQUE					
2802159	94083	0,5	3			x	
2702237	93072	1	3			x	
2702235	93071	0,8	3	x			
2702234	93070	1	3	x			
2702233	93069	1,5	3	x			
2702232	93068	2	3	x			
2702163	79354	0,7	2		x		
2702226	79599	0,5	2			x	
2702227	79245	1	2			x	
2702164	91006	-	2				x
2702165	91014	1	2	x			
2702231	80206	1,5	2	x			
2702236	83470	2	2	x			

N'hésitez pas à nous consulter pour des dimensions différentes.

Do not hesitate to contact us for customized dimensions.

Zur Auskunft bezüglich kundenspezifischer Dimension, wenden Sie sich an uns.

 **Tous matériaux**
All types of materials | Alle Materialien

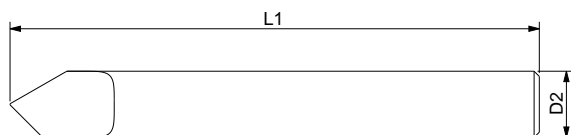

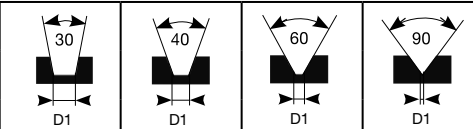
Cat-Nr GR	D1	D2	L1					
				D1	D1	D1	D1	
Ref.	LMT-Code	mm	mm / inch	mm / inch	MÉTRIQUE / INCH			
2731951	94161	0,1	3	30			x	
6550236	00185	0,1	3,17 (1/8")	38,1 (1 1/2")			x	
2731947	92175	0,1	4	60				x
6550234	00183	0,1	4,76 (3/16")	50,8 (2")				x
2731949	92176	0,1	6	60				x
6550235	00184	0,1	6,35 (1/4")	50,8 (2")				x
2731935	91096	0,2	4	60			x	
6550229	00177	0,2	4,76 (3/16")	50,8 (2")			x	
6550038	94163	0,3	3	30	x			
6550238	00187	0,3	3,17 (1/8")	38,1 (1 1/2")	x			
6550116	91100	0,3	4	60	x			
2739377	00181	0,3	4,76 (3/16")	50,8 (2")	x			
2731953	94162	0,3	3	30		x		
6550237	00186	0,3	3,17 (1/8")	38,1 (1 1/2")		x		
2731939	91098	0,3	4	60		x		
6550231	00179	0,3	4,76 (3/16")	50,8 (2")		x		
2731937	91097	0,4	6	60			x	
6550230	00178	0,4	6,35 (1/4")	50,8 (2")			x	
6550117	91101	0,5	6	60	x			
6550233	00182	0,5	6,35 (1/4")	50,8 (2")	x			
2731941	91099	0,5	6	60		x		
6550232	00180	0,5	6,35 (1/4")	50,8 (2")		x		

N'hésitez pas à nous consulter pour des dimensions différentes.

Do not hesitate to contact us for customized dimensions.

Zur Auskunft bezüglich kundenspezifischer Dimension, wenden Sie sich an uns.

Tous matériaux
 All types of materials | Alle Materialien

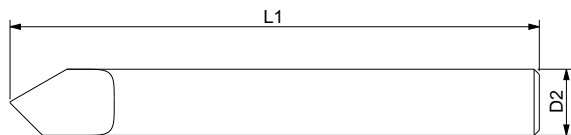

Cat-Nr GR		Ø D1		Ø D2		36° D1	L1
Ref.	LMT-Code	mm	inch	mm	inch		
INCH							
2701879	91400	0,32	0,012"	3,17	1/8"	36°	105
2701880	91400	0,5	0,02"	3,17	1/8"	36°	105
2701881	91400	0,75	0,03"	3,17	1/8"	36°	105
2701882	91400	1	0,04"	3,17	1/8"	36°	105
2701886	91401	0,32	0,012"	4,36	11/64"	36°	155
2701887	91401	0,5	0,02"	4,36	11/64"	36°	155
2701888	91401	0,75	0,03"	4,36	11/64"	36°	155
2701890	91401	1	0,04"	4,36	11/64"	36°	155

Cat-Nr GR		Ø D1		Ø D2		36° D1	L1
Ref.	LMT-Code	mm	inch	mm	inch		
INCH							
2701891	91401	1,25	0,05"	4,36	11/64"	36°	155
2722978	91401	1,5	0,06"	4,36	11/64"	36°	155
2701892	91401	2	0,078"	4,36	11/64"	36°	155
2722980	91401	2,3	0,09"	4,36	11/64"	36°	155
2701893	91401	3,17	0,125"	4,36	11/64"	36°	155
2701896	91402	0,32	0,012"	6,35	1/4"	36°	155
2701897	91402	0,5	0,02"	6,35	1/4"	36°	155

Fraise à graver pyramidale carbure monobloc GRP revêtue "X TIALN"
 Solid carbide pyramidal Engraving cutter GRP "X TIALN" coated /
 VHM Gravierfräser GRP "X TIALN" beschichtet

Fraise spéciale pour usinage de forme ou gravage de matériaux durs (acier inox, acier traité)

Special cutter for form manufacturing or engraving hard materials (stainless steel, treated steel)
 Sonderfräser für Formherstellung oder für Gravierung von harten Materialien (Stahl inox, behandeltem Stahl)

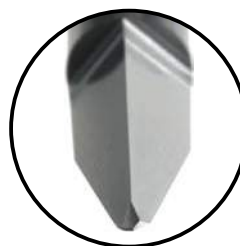
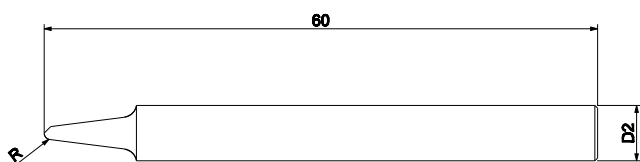

Cat-Nr GRP		15°	Ø D2	R
Ref.	LMT-Code		mm	mm
MÉTRIQUE				
2744163	00188	15°	6	0,7
2744165	00189	15°	4	0,3
2744159	00190	15°	4	0,15

Couteaux de semi-découpe

Knives

Klingen zum Schneiden von selbstklebenden Folien

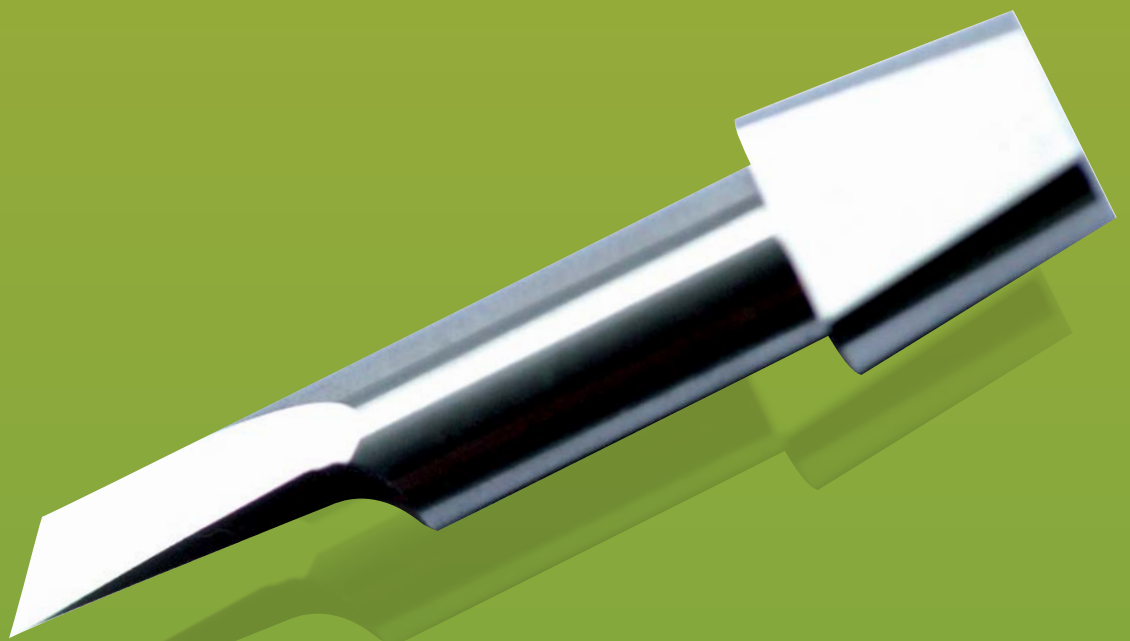

ARISTO : AG 50 • AG 130

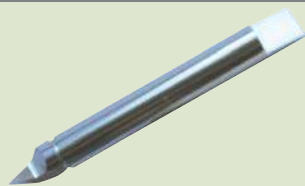

☀ Réf. 91112

☀ Réf. 94148

GRAPHITYP : CSR 466 - 700 - TURBO



☀ Réf. 91272

☀ Réf. 93196

CREAGRAPH

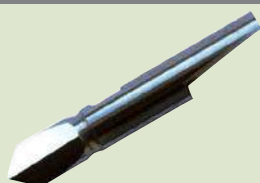

★ Réf. 94165

☀ Réf. 94166

GRAPHITYP : CSR 466 - 700 - TURBO

PCD

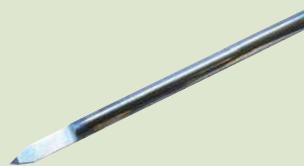

★ Réf. 93278

CSR ECOM 2



★ Réf. 93343

GRAPHIX : EUROVISION 375 - 750



★ Réf. 00176

GRAPHIX : GSX

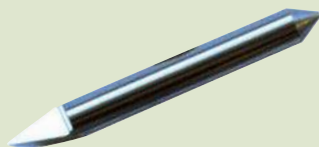

★ Réf. 94177

**GRAPHIX : 2 - 3 - 4 - SPRINT
SUPER SPRINT - ADVANTAGE**

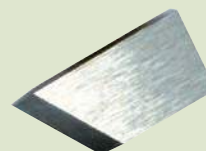

★ Réf. 84272

☀ Réf. 94147

★ Utilisation standard
Standard usage
Standardverwendung

☀ Outil spécial pour matériaux épais ou fluorescents
Special Tool for thick or fluorescent materials
Sonderwerkzeug für dicke oder fluoreszierende Stoffe

GRAPHTEC



★ Réf. 93342

MIMAKI



★ Réf. 94153 ✱ Réf. 94154

IOLINE



★ Réf. 94159 ✱ Réf. 94160

MUTHO



★ Réf. 96065 ✱ Réf. 94152

KONGSBERG

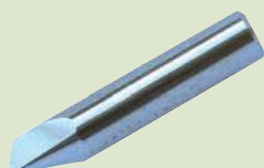

★ Réf. 92171 ✱ Réf. 92172

ROLAND : CAMM1 - PNC 1100 - 1500 1900 - 450

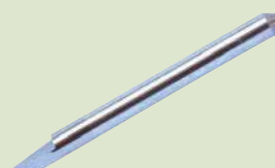

★ Réf. 91115 ✱ Réf. 92054

MECANUMERIC



★ Réf. 94046

SEI



★ Réf. 94155 ✱ Réf. 94156

★ Utilisation standard
 Standard usage
 Standardverwendung

✱ Outil spécial pour matériaux épais ou fluorescents
 Special Tool for thick or fluorescent materials
 Sonderwerkzeug für dicke oder fluoreszierende Stoff

SEI : 750 - 1400
 CSR : 1000 - 1200 - 2400



★ Réf. 94012

✳ Réf. 94151

WILD : TA 30 - 41/40 - 410 - 500
ZUND : P700 - P1200 PLUS - P2000



★ Réf. 95126

SUMMA GRAPHICS : T1300



★ Réf. 95242

WILD : TA 30 - 41/40 - 410 - 500
ZUND : P700 - P1200 PLUS - P2000



★ Réf. 91113

✳ Réf. 94149

SUMMA GRAPHICS : D610



★ Réf. 94170

✳ Réf. 94171

ZUND : P700 - P1200 PLUS - P2000

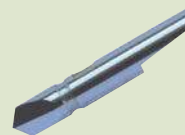

★ Réf. 91114

✳ Réf. 94150

WIDMATIC



★ Réf. 98293

ZUND



★ Réf. 2820322

NEW

★ Utilisation standard
 Standard usage
 Standardverwendung

✳ Outil spécial pour matériaux épais ou fluorescents
 Special Tool for thick or fluorescent materials
 Sonderwerkzeug für dicke oder fluoreszierende Stoffe



Vous avez des problématiques d'usinage complexes ?

Depuis sa création, LMT Belin s'engage à vos côtés pour vous proposer des solutions développées par nos techniciens adaptées à vos process. Nos compétences sur les matériaux plastiques, composites et métaux non-ferreux ainsi que les opérations d'alésage sont à votre disposition. N'hésitez pas à nous questionner!



You have special needs in terms of machining?

Since its creation LMT Belin offers special tools solutions developed by our engineers to meet your processes. A skilled team in plastics, composites, non-ferrous metals and reaming operations is at your disposal. Do not hesitate to contact us for further information.



Haben Sie Problematiken was komplexes Zerspanen angeht ?

Seit seiner Gründung, hat sich LMT Belin verpflichtet, Ihnen von unseren Technikern entwickelte und auf Ihren Prozess zugeschnittene Lösungen vorzuschlagen. Wir stellen Ihnen unsere Kompetenz in Sachen Kunststoffen, Komposites, Nichteisen-Metallen sowie Ausbohren/-drehen zur Verfügung. Kontaktieren sie uns doch einfach !



Accessoires

Accessories
Zubehör

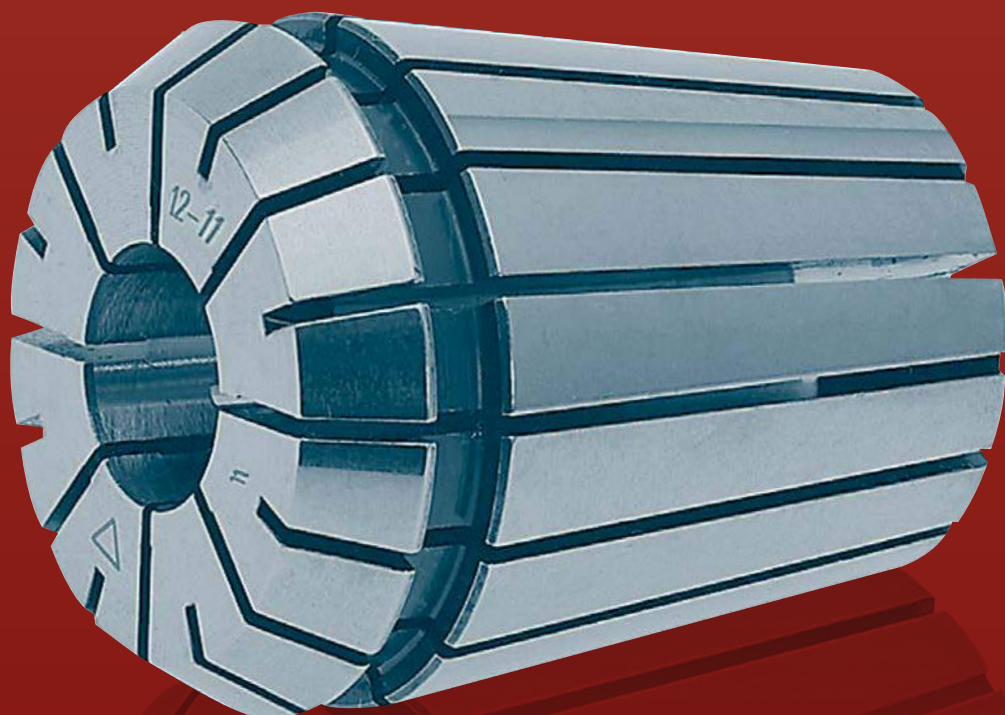

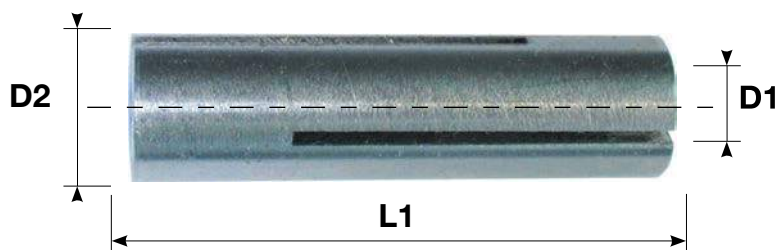

Ident-N°	LMT-Code	D1		D2		L1
		mm	inch	mm	inch	mm
MÉTRIQUE						
2782662	86060	3,5	-	6	-	20
2702159	86060A	2	-	4	-	20
2702187	86060B	2,5	-	4	-	20
2702188	86060C	3	-	4	-	20
2702189	86060D	2	-	6	-	20
2702190	86060E	2,5	-	6	-	20
2702191	86060F	3	-	6	-	20
2702192	86060G	4	-	6	-	20
2702197	86060L	3,17	1/8"	6	-	20
2702193	86060H	2	-	6,35	1/4"	20
2702194	86060I	2,5	-	6,35	1/4"	20
2702195	86060J	3	-	6,35	1/4"	20
2702196	86060K	4	-	6,35	1/4"	20
2709709	86060M	2	-	8	-	20
2709710	86060N	2,5	-	8	-	20
2709711	86060P	3	-	8	-	20
2709712	86060Q	4	-	8	-	20
2709713	86060R	5	-	8	-	20
2709714	86060S	6	-	8	-	20
2711226	86060V	5	-	6	-	20



CONSEILS D'EXPERTS

Cet accessoire permet d'adapter un outil coupant à diamètre de queue plus petite que la pince disponible.
Nous préconisons cependant l'emploi de la pince adaptée (Diamètre de la pince = Diamètre de la queue de l'outil).

/ This accessory allows you to adapt a cutting tool that have a smaller shank diameter than the collet.
We recommend to use the adapted collet (Collet diameter = tool shank diameter)

/ Dieses Zubehör erlaubt es Ihnen einen kleineren Schaftdurchmesser als den Spannzandurchmesser zu spannen. Wir empfehlen jedoch für ein besseres Spannen eine Spannzange mit den geeigneten Durchmesser zu verwenden.

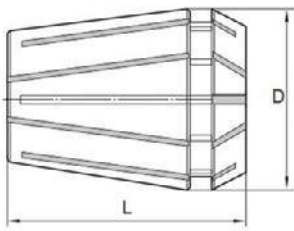

	D (mm)	L (mm)
ER16	17	27,5
ER20	21	31,5
ER25	26	34
ER32	33	40



Tolérances de battement radial des pinces ER

Radial runout tolerances for ER collets

Rundlauf toleranzen von Spannzangen

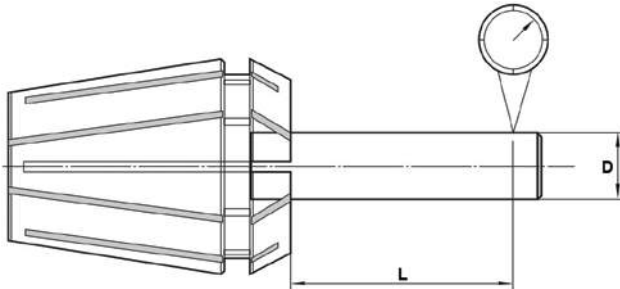

D1	L	→
2 - 3	10	0,01
4 - 5 - 6	16	0,01
7 - 8 - 10	25	0,01
12,7	40	0,01

EXEMPLE :

Pour une pince de Ø5, le défaut de concentricité maxi de 0,01 est mesuré à une valeur de sortie de 16 mm.

For a Ø5 collet, maximum concentricity default is 0,01 measured at 16 mm from collet end.

F r eine Ø5 Spannzange, wird eine maximale Rundlaufabweichung von 0,01mm in einem Abstand von 16mm vom Spangenende gemessen.

Ident-N°	Plage de serrage [ØXX à ØXX] Diameter range [from ØXX to ØXX] Spanndurchmesser [von ØXX bis ØXX]
Pince ER16	
2868197	Ø 1,0 à Ø 0,5
2703094	Ø 2,0 à Ø 1,0
2703103	Ø 2,5 à Ø 1,5
2703104	Ø 3,0 à Ø 2,0
2727332	Ø 3,5 à Ø 2,5
2703106	Ø 4,0 à Ø 3,0
2703105	Ø 5,0 à Ø 4,0
2703107	Ø 6,0 à Ø 5,0
2709474	Ø 6,5 à Ø 5,5
2864483	Ø 7,0 à Ø 6,0
2703108	Ø 8,0 à Ø 7,0
2733171	Ø 10,0 à Ø 9,0

Ident-N°	Plage de serrage [ØXX à ØXX] Diameter range [from ØXX to ØXX] Spanndurchmesser [von ØXX bis ØXX]
Pince ER25	
2727460	Ø 2,0 à Ø 1,0
2729310	Ø 2,5 à Ø 1,5
2730631	Ø 3,0 à Ø 2,0
2727186	Ø 3,5 à Ø 2,5
2729063	Ø 4,0 à Ø 3,0
2728571	Ø 5,0 à Ø 4,0
2727473	Ø 6,0 à Ø 5,0
2729240	Ø 6,5 à Ø 5,5
2731146	Ø 7,0 à Ø 6,0
2727177	Ø 8,0 à Ø 7,0
2728651	Ø 10,0 à Ø 9,0
2817906	Ø 12,0 à Ø 11,0
2727592	Ø 13,0 à Ø 12,0

Ident-N°	Plage de serrage [ØXX à ØXX] Diameter range [from ØXX to ØXX] Spanndurchmesser [von ØXX bis ØXX]
Pince ER20	
2800734	Ø 2,0 à Ø 1,0
2800736	Ø 3,0 à Ø 2,0
2800738	Ø 4,0 à Ø 3,0
2825636	Ø 5,0 à Ø 4,0
2800742	Ø 6,0 à Ø 5,0
2790034	Ø 8,0 à Ø 7,0
2800746	Ø 10,0 à Ø 9,0

Ident-N°	Plage de serrage [ØXX à ØXX] Diameter range [from ØXX to ØXX] Spanndurchmesser [von ØXX bis ØXX]
Pince ER32	
2783948	Ø 2,0 à Ø 1,0
2755534	Ø 3,0 à Ø 2,0
2772160	Ø 4,0 à Ø 3,0
2793268	Ø 5,0 à Ø 4,0
2772162	Ø 6,0 à Ø 5,0
2821560	Ø 7,0 à Ø 6,0
2790593	Ø 8,0 à Ø 7,0
2788706	Ø 9,0 à Ø 8,0
2788708	Ø 10,0 à Ø 9,0
2824855	Ø 11,0 à Ø 10,0
2790595	Ø 12,0 à Ø 11,0
2867314	Ø 13,0 à Ø 12,0



CONSEILS D'EXPERTS

Diamètre de l'outil : 5 mm
Sélectionner la pince ER de plage 5 à 4 et éviter l'utilisation d'une pince 6 à 5 (défaut de concentricité plus important, diminution de la rigidité de l'ensemble)

/ Tool diameter : 5mm
Choose the ER collet from 5 to 4 and avoid using a 6 to 5 (concentricity problem more important, less rigidity of the tool and collet)

/ Werkzeugdurchmesser : 5 mm
Nutzen Sie ein Spannzange von 5 bis 4 mm und nicht ein von 6 bis 5 mm (Konzentritz tsfehler und geringere Steifigkeit)

Conseils techniques

Technical notes
Technische Anmerkungen



Conseils d'usinage

Introduction

Pour profiter pleinement de la performance des produits LMT il est nécessaire que vos machines soient entretenues de manière régulière selon les directives du constructeur (planning de maintenance, réglage, nettoyage, ...). Le suivi de ces consignes vous permettra de disposer des meilleures performances.

Fixation des pièces

L'optimisation du maintien des pièces est important à la fois pour la qualité des pièces produites mais aussi pour la durée de vie de l'outil et de la machine. La matière première doit être fixée convenablement pour ne pas bouger et générer le moins de vibrations possibles.

Conditions de coupe

Diamètre de l'outil	D	mm
Nombre de dents	Z	
Vitesse de coupe	Vc	m/min
Nombre de tours	N	tr/min
Avance à la dent	Fz	mm/z
Avance de travail	Vf	mm/min

MATERIAUX	Vc	AVANCE A LA DENT : Fz (mm/dent)			
		D < Ø3	Ø3 < D < Ø5	Ø5 < D < Ø8	Ø8 < D < Ø14
Aluminium pur	200 à 400	0,01 - 0,03	0,025 - 0,045	0,05 - 0,075	0,08 - 0,12
Aluminium alliage	200 à 400	0,01 - 0,03	0,025 - 0,045	0,05 - 0,075	0,08 - 0,12
Laiton	150 à 300	0,008 - 0,02	0,02 - 0,04	0,035 - 0,05	0,05 - 0,08
Bronze	100 à 150	0,008 - 0,02	0,02 - 0,04	0,035 - 0,05	0,05 - 0,08
Plastiques-Bakélite	50 à 100	0,025 - 0,04	0,055 - 0,08	0,08 - 0,12	0,12 - 0,2
Plastiques-PVC	100 à 200	0,025 - 0,06	0,06 - 0,09	0,1 - 0,18	0,15 - 0,2
Thermoplastiques Acétate, Plexiglass, Nylon	300 à 500	0,01 - 0,035	0,025 - 0,045	0,045 - 0,08	0,08 - 0,16
Bois	300 à 400	0,015 - 0,035	0,03 - 0,05	0,05 - 0,075	0,08 - 0,12
Acier Inox	50 à 90	0,008 - 0,015	0,01 - 0,03	0,025 - 0,045	0,04 - 0,065

MATERIAUX	Vc	AVANCE A LA DENT : Fz			
		D < Ø3	Ø3 < D < Ø5	Ø5 < D < Ø8	Ø8 < D < Ø14
Thermoplastiques Acétate Plexiglass Nylon	300 à 500	0,01 - 0,035	0,025 - 0,045	0,045 - 0,08	0,08 - 0,16

Calcul de la rotation de la broche:	$N = \frac{1000 Vc}{\pi D}$
Calcul de l'avance d'usinage:	$Vf = Fz \times Z \times N$

EXEMPLE :

Diamètre de l'outil D=6
Nombre de dents Z=1
Matière usinée : Plexiglass

Vitesse de coupe Vc=400
Avance à la dent fz=0.06

CALCUL :

N = 21 221 tr/min
Vf = 1 273 mm/min

Opérations de plongée

Plus la matière à usiner est dure plus la vitesse de plongée devra être réduite.

Réduire la vitesse de plongée permettra notamment de prévenir toute rupture de l'outil. Cette règle s'applique également pour les outils à petits diamètres ou à très grande longueur de coupe.

Exemples :

- > Plastiques/Bois :
entre 40% et 60% de l'avance calculée (mm par minutes)
- > Aluminium/Non-ferreux :
entre 35% et 50% de l'avance calculée (mm par minutes)
- > Acier/Métaux ferreux :
entre 20% et 30% de l'avance calculée (mm par minutes)

Prise de passe 'Ae'

Il est important de suivre les recommandations données dans le tableau de calcul des données de coupe. Pour les petits diamètres et les matériaux durs il est recommandé de diminuer l'Ae.

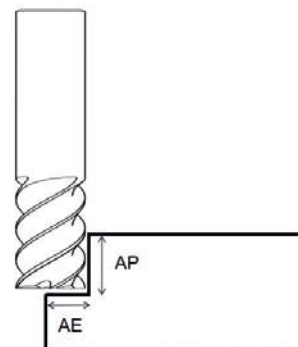

Problèmes les plus fréquemment rencontrés lors de l'usinage avec les fraises de découpes (Type 12000, 13000, 22000, 33000, CRISTAL, GDA, ...)		
Problèmes	Causes possibles	Mesures à prendre
Casse ou écaillage de l'outil Mauvais état de surface sur la pièce usinée	Pince abîmée	Changer la pince
	Porte à faux trop important	Serrer la fraise au plus près de la fin de la goujure. Utiliser, si possible, une fraise avec une longueur utile plus faible Réduire les conditions de coupe
	Serrage sur la goujure	Serrer la fraise au plus près de la fin de la goujure
	Jeu dans la broche	Révision de la broche
	Jeu dans la table	Révision de la machine
	Défaut de concentricité du porte outil	Nettoyage de la broche et du porte outil ou échange du porte outil
	Pièce usinée mal maintenue	Diminuer les efforts de coupe en réduisant les hauteurs de prises de passe et l'avance
	Condition de coupe inadaptée	Recalculer les vitesses de rotation et d'avance
Usure trop rapide de l'outil	Condition de coupe inadaptée	Recalculer les vitesses de rotation et d'avance
	Défaut de lubrification	Pour l'aluminium : lubrifier avec une émulsion d'huile de coupe, ou avec un système de micro pulvérisation ou utiliser une fraise revêtue. Pour les matières plastique : refroidir la fraise avec un jet d'air
Traces de brûlures sur la pièce usinée	Vitesse de rotation trop élevée ou avance trop faible	Diminuer la vitesse de rotation ou augmenter l'avance

Influence de la puissance de la broche

Les avances indiquées dans nos catalogues sont adaptées à des broches de puissance égale ou supérieure à 2KW. Il est conseillé de les diviser par deux pour les broches de puissance inférieure à 2KW.

Broche de puissance inférieure à 1KW : L'utilisation de fraises de diamètre supérieur à 6mm est déconseillée pour effectuer des découpes.

Sens d'hélice

Une fraise hélice à droite, coupe à droite (fraises 13 000, 33 000, CRISTAL, GDA, ...) a tendance à tirer la pièce usinée vers le haut : les copeaux sont très bien évacués mais la pièce doit être suffisamment maintenue pour éviter toutes vibrations.

Une fraise hélice à gauche, coupe à droite (fraise série 12000, 22000) a tendance à pousser la pièce usinée contre la table de la machine : la pièce sera moins soumise à des problèmes de tenue mais les copeaux seront mal évacués (risque de bourrage des copeaux).

Maintenance des pinces de serrage

Introduction

La rigidité est un facteur important lors des opérations d'usinage. Les problèmes associés à la rigidité impliquent à la fois l'outil et la machine. Les pièces doivent être maintenues par des systèmes de serrage adaptés et la machine doit être correctement entretenue afin de garantir la meilleure qualité d'usinage.

Un des éléments clés de ce processus est le lien existant entre la broche et l'outil : la pince de serrage.

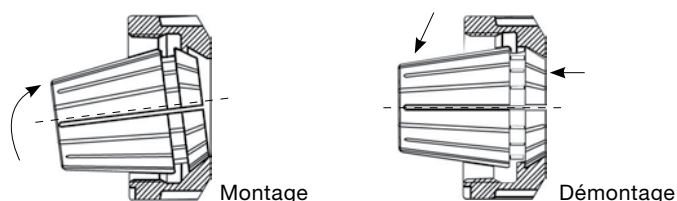

Utilisation

Pour profiter au mieux des capacités de serrage offertes par les pinces, l'outil doit être introduit sur au moins 80% de la longueur de la pince. La préhension se fera sur une très grande longueur et permettra à l'outil de tourner de manière concentrique. Sans une bonne concentricité, l'état de surface sur la pièce usinée sera dégradé et l'outil pourra subir des dommages irréversibles.

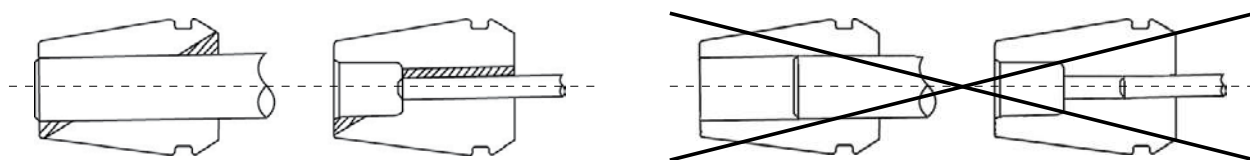

La « règle » des 80% peut ne pas être applicable. Dans ce cas, il est nécessaire d'ajouter au fond de la pince un cylindre de diamètre équivalent au diamètre de queue de la fraise de façon à mieux répartir les efforts de serrage.

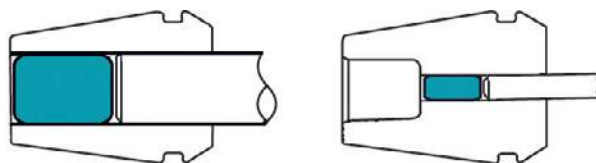

Pour limiter au maximum le porte-à-faux, serrer l'outil au plus près de la fin de la goujure sans toutefois serrer sur celle-ci. Le non-respect de ces conditions d'utilisation peut engendrer une usure prématurée et/ou casse de l'outil.

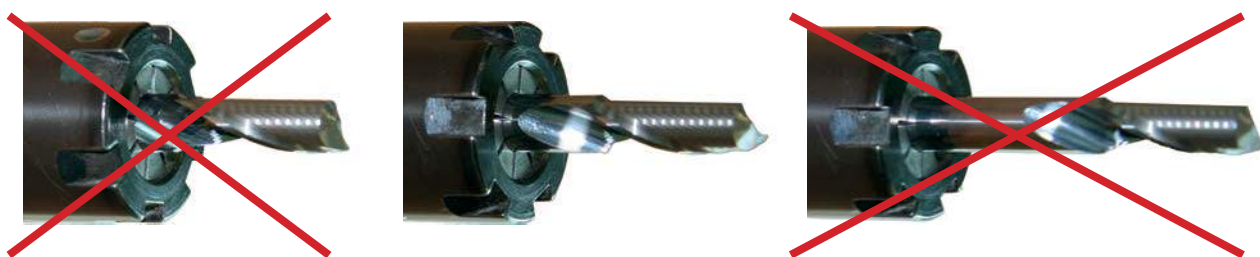

Maintenance des pinces de serrage

Lors des phases d'usinage, des résidus viennent se loger dans les pinces. Ces systèmes de fixation doivent donc être entretenus. A chaque changement d'outil, nettoyer impérativement la pince et le porte-outil de manière rigoureuse puis préserver les pinces de serrage de l'oxydation en appliquant un produit de type antirouille.

Remplacement des pinces

Les pinces sont soumises à des contraintes régulières et perdent peu à peu de leur élasticité. Un changement régulier des pinces toutes les 400-600 heures d'usinage devrait être prévu comme maintenance préventive. Une casse d'outil peut endommager la pince, plus particulièrement si la rupture intervient à l'intérieur de celle-ci. Dans ce cas, il est vivement conseillé de la remplacer. Nous conseillons également le changement de la pince si la fréquence des ruptures d'outil est en augmentation.

Technical information

Introduction

Follow the CNC machine manufacturer guidelines for setup — alignment — calibration and maintenance schedules. Regular attention to these guidelines will keep your CNC machine in top operating condition. LMT Precision Tools work best in well-maintained CNC machines giving excellent cutting performance and longer tool life.

CNC Rigidity – Setup

Machine stability is when material hold down is achieved with no movement and minimal vibration. Also, consider that software programs need to be verified and the spindle(s) aligned and calibrated, creating the optimum working conditions to minimize runout side pressures giving the best cut/edge quality and longer tool life.

Cutting conditions

Tool diameter	D	mm
Number of flutes	Z	
Cutting speed	Vc	m/min
RPM	N	Tr/min
Feed per tooth	Fz	mm/z
Feed rate	Vf	mm/min

Spindle rotation formula	$N = \frac{1000 Vc}{\pi D}$
Feed rate calculation	$Vf = Fz \times Z \times N$

MATERIALS	Vc	FEED PER TOOTH Fz			
		D < Ø3	Ø3 to Ø5	Ø5 to Ø8	Ø8 to Ø14
Pur Aluminium	200 to 400	0,01 - 0,03	0,025 - 0,045	0,05 - 0,075	0,08 - 0,12
Aluminium alloys	200 to 400	0,01 - 0,03	0,025 - 0,045	0,05 - 0,075	0,08 - 0,12
Brass	150 to 300	0,008 - 0,02	0,02 - 0,04	0,035 - 0,05	0,05 - 0,08
Bronze	100 to 150	0,008 - 0,02	0,02 - 0,04	0,035 - 0,05	0,05 - 0,08
Plastics-Bakelite	50 to 100	0,025 - 0,04	0,055 - 0,08	0,08 - 0,12	0,12 - 0,2
Plastics-PVC	100 to 200	0,025 - 0,06	0,06 - 0,09	0,1 - 0,18	0,15 - 0,2
Thermoplastics Acetate, Plexiglass, Nylon	300 to 500	0,01 - 0,035	0,025 - 0,045	0,045 - 0,08	0,08 - 0,16
Wood	300 to 400	0,015 - 0,035	0,03 - 0,05	0,05 - 0,075	0,08 - 0,12
Stainless steel	50 to 90	0,008 - 0,015	0,01 - 0,03	0,025 - 0,045	0,04 - 0,065

This example shows that we use a Ø6 tool with 2 flutes; Cutting speed is 300 m/min, Feed per tooth is 0,035 mm/round. With these data we calculated the cutting conditions for the tool.

EXAMPLE :

Tool diameter D=6
 Number of flutes Z=1
 Material to machine : Acetate Plexiglass
 Cutting speed Vc=400
 Feed per tooth fz=0.06

CALCULATION :

N = 21 221 tr/min
 Vf = 1 273 mm/min

MATERIALS	Vc	FEED PER TOOTH Fz			
		D < Ø3	Ø3 < D < Ø5	Ø5 < D < Ø8	Ø8 < D < Ø14
Thermoplastics Acetate, Plexiglass, Nylon	300 à 500	0,01 - 0,035	0,025 - 0,045	0,045 - 0,08	0,08 - 0,16

Plunging the material

Harder the material to be routed/milled, the softer you should plunge. Reducing the plunge helps to avoid damaging the tool as it “hits” the material. Consider slower plunge when using small diameter tools, extra long cutting length tools and flatter tipped tools.

Examples :

- > Plastic/Wood – 40-60% of the calculated feed rate [IPM]
- > Aluminum/Non-Ferrous – 35-50% of the calculated feed rate [IPM]
- > Steel/Ferrous Metal – 20-30% of the calculated feed rate [IPM]

Depth of cut ‘Ae’

Important to follow the recommended ‘Ae’ listed on the Belin Cutting Formula Chart. Smaller cutting edge diameters and harder material being routed/milled require the depth of cut ‘Ae’ be reduced. Exceeding the recommended ‘Ae’ can contribute to less than optimal edge quality, shorter tool life and tool breakage.

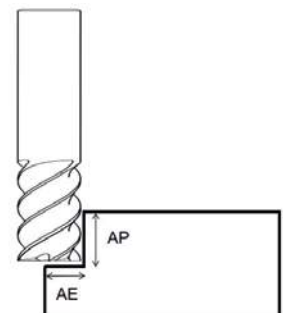

➔ Troubleshooting

Most common problems while machining with following one flute references (12000, 13000, 22000, 3300)		
Problems	Diagnose	Solve
Tool breakage Bad surface state of the workpiece	Damaged collet	Change the collet
	Important overhang	Use if possible a tool with a shorter cutting length
	Colleting on the flute	The mouth or bottom of the collet must contact the tool bit slightly above the flute fadeout
	Loose in the spindle	Spindle maintenance
	Loose in the table	Machine maintenance
	Concentricity problem on the tool holder	Clean the spindle and the tool holder or change the tool holder
	Workpiece not maintained	Lower cutting conditions (Ap and/or Ae) and feed rate.
	Collet not adapted to the shank length	Use a different tool with a different shank length
Wear on the tool	Not adapted cutting conditions	Calculate the right cutting conditions or ask your sales representative
	Coolant problem	For Aluminium : cool the process with cutting oil or micro-cooling or use a coated tool. For plastic materials : Use air cooling
Burn mark on the workpiece	Too high RPM or too low feed rate	Lower RPM or increase feed rate

Spindle power influence

The cutting conditions given in our catalogues are adapted for spindles power equals or superior to 2 KW. It is highly recommended to divide by two those latter for spindles that are less than 2KW.

Spindle power less than 1KW: We advise you against the use of tools with a higher diameter than 6mm.

Flute geometry

An upcut endmill (series 13000 and 33000) tend to attract the workpiece to the spindle. The chips are well evacuated but the workpiece has to be well maintained to avoid vibrations.

A downcut endmill (series 12000 and 22000) tend to push the workpiece in the opposite direction (it pushes the workpiece down). The workpiece will undergo less vibrations but you may encounter chips evacuation troubles (depending on the holding system used).

➔ Proper colleting

In all router bits, there is an area known as the flute fadeout section of the tools. This is formed when the grinding wheel utilized in the manufacturing of the tool exits the work piece. In order to properly collet a router bit, the mouth or bottom of the collet must contact the router bit slightly above the flute fadeout. Overcolleting or allowing the flute fadeout portion to extend inside the collet can damage the collet and is a common cause of tool breakage.



Proper colleting and maintenance

Introduction

Rigidity is a key factor in the routing of plastic material. The problems associated with rigidity involve the part, as well as the machine. Parts must be held solidly with established fixturing techniques, and the machine must be appropriately maintained to insure the cutting tool is following the proper tool path in a rigid and concentric fashion.

One of the elements that aids in this whole process lies in the area of proper colleting of the router bit and the on-going maintenance procedure associated with router collets.

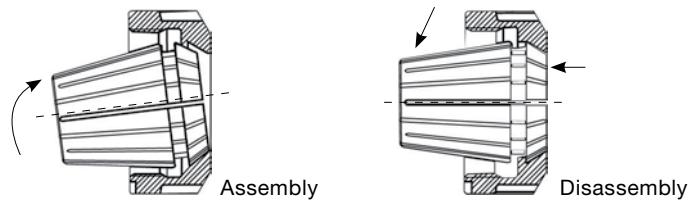

Use

The proper method of colleting a router bit in the full grip collet is to fill at least 80% of the depth of the collet. This allows the tool to be equally distributed on all sections of the collet and provides an environment where the tool runs in a true circle or concentrically. Without concentricity, the finish of the plastic part is adversely affected, and tool failure can occur.

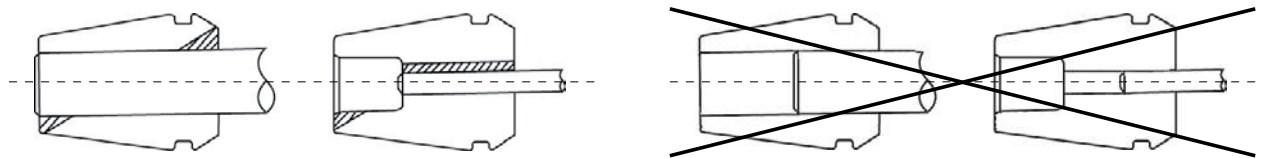

There are situations where the 80% rule cannot be maintained because of inadequate shank lengths or extreme reach problems. Consequently, it becomes necessary to fill the void in the top of the collet with a filler or collet life plug. This is a practical solution to avoid collapsing of the collet, which may result from not following the 80% rule.

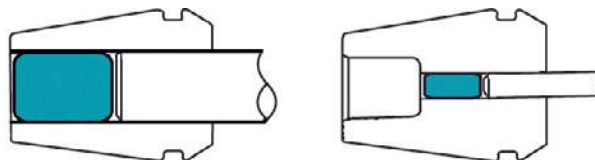

Collets maintenance

Router bits and collets are expected to operate accurately in a work environment inundated with heat and grime. Plastic chips formed by the cutting action of the router bit carry with them resins that migrate through the slits of the collets and adhere to the inside of this closely toleranced mechanism. The resin build up usually concentrates nearest the mouth of the collet. At this point, the tool is no longer being equally gripped causing a loss in concentricity and tool run out. Once again, the lack of a router tool running in a true circle affects the finish of the part and may cause the ultimate demise of the tool. Fortunately, this problem is easily resolved by cleaning the collets after every tool change. The procedure involves the use of non-abrasive brass tube brush applied inside the collet in combination with a cleaner such as Rust Free.

Collet replacement

Collets are manufactured from spring steel and regular usage causes a loss of elasticity. Therefore, it becomes necessary to replace collets on a regular interval as a part of an on-going maintenance procedure. With diligent attention to proper collet maintenance, the average collet should be replaced about every 400-600 hours of run time. Avoiding regular replacement can lead to brittle collets, which may crack or break, and cause permanent damage to the spindle. Replacement of collets is a much more economical alternative than replacing router bits or expensive spindles.

Technische Information

Einführung

Um mit voller Leistung von LMT-Produkten geniessen zu können ist es notwendig, dass Ihre Maschinen regelmässig geprüft und gewartet werden. Je nach Wartungsvorschriften der Maschinenbauer (Wartungsplanung, Einstellung, Reinigung,...)

Eine sorgfältige Verfolgung dieser Anweisungen erlaubt Ihnen über eine bessere Leistung Ihrer Maschine zu verfügen und somit auch der Schneidwerkzeuge.

Das Aufspannen der Teile

Ein optimales Spannen der Teile am Frästisch ist wichtig, besonders für eine gute Einhaltung der Fräsqualität am Teil aber auch für die Standzeit der Werkzeuge und Lebensdauer der Maschine. Das Material sollte so gut wie möglich gespannt sein, um ein Bewegen des Teiles während des Fräsvorgangs zu verhindern – Vibrationen (Rattermarken) werden somit reduziert. Eine gut gewählte Frässtrategie mit optimalen Schnittparametern garantieren das beste Ergebnis.

Werkzeugdurchmesser	D	mm
Anzahl der Schneiden	Z	
Schnittgeschwindigkeit	Vc	m/min
Drehzahl	N	1/min
Zahnvorschub	Fz	mm/Zahn
Vorschub	Vf	mm/min

Berechnung der Drehzahl	$N = \frac{1000 Vc}{\pi D}$
Vorschubberechnung	$Vf = Fz \times Z \times N$

		VORSCHUB PRO ZAHN : Fz			
WERKSTOFF	Vc	D < Ø3	Ø3 bis Ø5	Ø5 bis Ø8	Ø8 bis Ø14
reines Aluminium	200 bis 400	0,01 - 0,03	0,025 - 0,045	0,05 - 0,075	0,08 - 0,12
Aluminiumlegierung	200 bis 400	0,01 - 0,03	0,025 - 0,045	0,05 - 0,075	0,08 - 0,12
Messing	150 bis 300	0,008 - 0,02	0,02 - 0,04	0,035 - 0,05	0,05 - 0,08
Bronze	100 bis 150	0,008 - 0,02	0,02 - 0,04	0,035 - 0,05	0,05 - 0,08
Bakelit	50 bis 100	0,025 - 0,04	0,055 - 0,08	0,08 - 0,12	0,12 - 0,2
PVC	100 bis 200	0,025 - 0,06	0,06 - 0,09	0,1 - 0,18	0,15 - 0,2
Thermoplasten Azetat, Plexiglas, Nylon	300 bis 500	0,01 - 0,035	0,025 - 0,045	0,045 - 0,08	0,08 - 0,16
Holz	300 bis 400	0,015 - 0,035	0,03 - 0,05	0,05 - 0,075	0,08 - 0,12
Edelstahl	50 bis 90	0,008 - 0,015	0,01 - 0,03	0,025 - 0,045	0,04 - 0,065

		VORSCHUB PRO ZAHN : Fz			
WERKSTOFF	Vc	D < Ø3	Ø3 < D < Ø5	Ø5 < D < Ø8	Ø8 < D < Ø14
Thermoplasten Azetat, Plexiglas, Nylon	300 bis 500	0,01 - 0,035	0,025 - 0,045	0,045 - 0,08	0,08 - 0,16

BEISPIEL für :

Vc = 400 und D = 6, N = 15915 1/min

Fz = 0,035 Z = 2 und den Wert N (siehe oben)
Vf = 1114 mm/min

BEISPIEL :

Werkzeugdurchmesser D = 6
Anzahl der Schneiden Z = 1
zu bearbeitender Werkstoff : Plexiglass

Schnittgeschwindigkeit Vc = 400
Zahnvorschub fz = 0,06

BERECHNUNG :

N = 21 221 1/min
Vf = 1273 mm/min

Eintauchen ins Material

Je härter der zu bearbeitende Werkstoff desto geringer muss der Eintauchvorschub gewählt werden.

Das Reduzieren des Vorschubes verhindert :

- Zusammenstoss zwischen Werkzeug und Werkstück
- Werkzeugbruch

Bei kleinen Werkzeugdurchmessern und grossen Schneidlängen ist es ebenfalls notwendig den Vorschub zu reduzieren.

Beispiele :

- > Kunststoff/Holz :
zwischen 40% und 60% des berechneten Vorschubes (mm/min)
- > Aluminium/Nichteisenmetalle :
zwischen 35% und 50% des berechneten Vorschubes (mm/min)
- > Stahl/Eisenmetalle :
zwischen 20% und 30% des berechneten Vorschubes (mm/min)

Schnitttiefe "ap"

Wichtig! Bitte Angaben aus der Schnittdatentabelle entnehmen (Seite?). Bei kleinen Durchmessern und bei harten Werkstoffen schlagen wir vor die Schnitttiefe "ap" zu verringern.

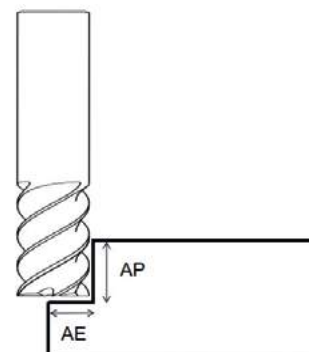

➔ Beheben von aufkommenden Problemen

Meist vorkommende Probleme beim Fräsen mit Fräsertypen (12000, 13000, 22000, 33000)		
Probleme	Mögliche ursache	Lösung
- Bruch des Werkzeuges oder ein Abplatzen der Schneide - Schlechte Oberflächengüte am Teil	Beschädigte Spannzange	Spannzange wechseln
	Zu grosse Auskraglänge des Werkzeuges	Spannen des Werkzeuges Ende Spannutt/Spannzangenfläche Werkzeug so kurz wie möglich wählen
	Spannut in der Spannzange	Ende Spannutt/Spannzangenfläche
	Spindelspiel	Wartung der Spindel
	Tischspiel	Wartung der Maschine
	Konzentritätsfehler der Aufnahme	Säubern der Spindel und der Aufnahme, evtl. Neue Aufnahme wählen
	Schlechte Aufspannung des Teiles	Kleinere Schnitttiefen wählen, Vorschub verringern
	Schaftlänge des Werkzeuges stimmt mit der Spannzange nicht überein	Werkzeug mit passender Schaftlänge wählen
Frühzeitiger Werkzeugverschlei	Schlechte Schnittdaten	Neue Schnittdaten errechnen
	Keine Kühlung	Bei Aluminium : Kühlung mit Emulsion (Schneidöl) oder MMS (Minimalmengenschmierung) oder nutzen Sie ein beschichtet Werkzeug Bei Kunststoff : Luft
Brandspuren am Teil	Zu hohe Drehzahl Zu geringer Vorschub	Drehzahl verringern Vorschub erhöhen

Einfluss der Spindelleistung

Angegebene Vorschübe im Katalog für Spindelleistungen von 2 KW oder mehr. Bei Spindelleistungen kleiner als 2 kw sollte der Vorschub auf 50% des angegebenen Vorschubes reduziert werden.

Bei Besäumungsarbeiten mit einer Spindelleistung kleiner als 1 KW empfehlen wir die Werkzeugdurchmesser gleich / kleiner Ø 6 mm zu wählen.

Drallrichtung

Ein Fräser mit Rechtsdrall, rechtsschneidend (Fräsertypen 13000 ; 33000) zieht das Werkstück nach oben : Sehr gute Spanabfuhr, jedoch muss das zu bearbeitende Teil sehr gut gespannt sein um jeglich Vibrationen zu verhindern.

Ein Fräser mit Linksdrall, rechtsschneidend (Fräsertypen 12000, 22000) drückt das zu bearbeitende Teil gegen den Tisch : Geringere Vibrationen, jedoch schlechte Spanabfuhr (Spannester)

➔ Spannzangen Vorschrift

Eine schlechte Einstellung kann zur Beschädigung der Spannzange und des Werkzeuges führen.



Spannzangen Vorschrift

Einführung

Bei der Bearbeitung von Kunststoffen spielt die Steifheit eine grosse Rolle. Das betrifft im Allgemeinen Werkzeuge und Maschine. Korrekte Spannelemente sowie eine regelmässige Wartung der Maschine garantieren einen stabilen und konzentrischen Werkzeugablauf.

Einst der wichtigsten Elemente dieses Verfahrens ist die existierende Verknüpfung zwischen der Spindel und des Werkzeuges, die Spannzange.

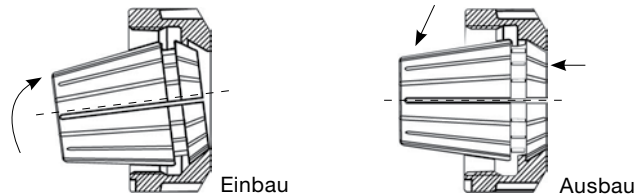

Anweisung

Um am besten von der Spannkapazität der Spannzangen zu profitieren, sollte der Werkzeugschaft bis mindestens 80% der Spannzangenlänge gespannt werden. Das Klemmen des Werkzeugschaftes geschieht innerhalb einer relativ grossen Länge. Dies verbessert die Konzentrität des Werkzeuges und resultiert mit einem ruhigeren Programmablauf. Konzentritätsfehler können zu einer mangelhaften Oberflächengüte des Teiles führen und zur frühzeitigen Zerstörung des Werkzeuges.

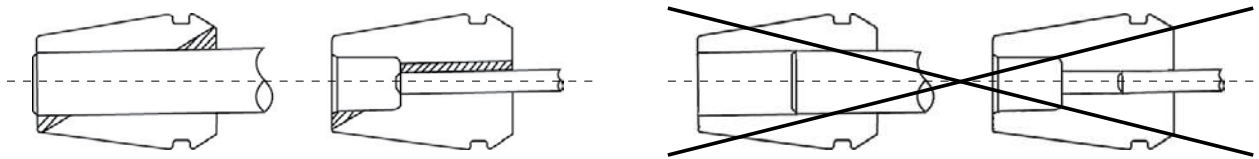

Die "Grundregel" von 80% kann bei bestimmten Werkzeugen nicht funktionieren. (Da Schaftlänge zu kurz !) Dies kann mit einem Drehzapfen, der den gleichen Durchmesser, wie der Schaftdurchmesser des Werkzeuges besitzt, behoben werden. Der Zapfen muss am Spannzangenende reingeschoben werden. Ein anderer Hinweis für die korrekte Aufnahme des Werkzeuges ist, dass das Ende der Werkzeugspannut ein wenig aus der Spannzangenfläche (Stirnseite)herausragen sollte.

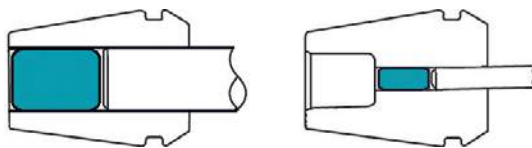

Instandhaltung der Spannzangen

Während der Bearbeitung können sich Materialreste (Staub) in den Nuten der Spannzange ansammeln. Die hochpräzisen Spannzangen sollten deshalb, nach jedem Einsatz, mit geeigneten Mitteln gereinigt werden.

Austausch einer Spannzange

Die Spannzangen sind einer regelmässigen Belastung ausgesetzt und verlieren nach einiger Zeit an ihrer Elastizität. Ein regelmässiger Austausch der Spannzangen nach ca. 400 – 600 Stunden Bearbeitungszeit wird empfohlen und sollte in der allgemeinen Wartung der Maschine eingeführt werden.

« Retrouver l'ensemble de la gamme LMT Tools sur www.lmt-belin.com »

“Further information on LMT Tools products at www.lmt-tools.com”

“Weitere Informationen über LMT Tools Leistungen www.lmt-tools.com”



Taillage d'engrenages, alésage, taraudage, fraisage, perçage, roulage.

Gear cutting, reaming, tapping, milling, rolling, drilling.

Verzahnen, reiben, bohren, gewinden, rollen, fräsen.

Brasilien/Brazil

LMT Boehlerit Ltda.
Alameda Caiapós, 693
Centro Empresarial
Tamboré
06460-110 – Barueri
São Paulo
Telefon +55 11 55460755
Telefax +55 11 55460476
lmtvendas@lmt.com.br

China

LMT China Co. Ltd.
No. 8 Phoenix Road,
Jiangning Development Zone
211100 Nanjing
Telefon +86 25 52128866
Telefax +86 25 52106376
lmt.cn@lmt-tools.com

Deutschland/Germany

LMT Tool Systems GmbH
Heidenheimer Strasse 84
73447 Oberkochen
Telefon +49 7364 9579-0
Telefax +49 7364 9579-8000
lmt.de@lmt-tools.com

Frankreich/France

LMT Belin France S.A.S.
Lieu dit „Les Cizes“
01590 Lavancia
Telefon +33 474 758989
Telefax +33 474 758990
lmt.fr@lmt-tools.com

LMT Belin France S.A.S.

Lieu dit „Les Cizes“
01590 Lavancia
Frankreich
Telefon +33 474 758989
Telefax +33 474 758990
info@lmt-belin.com
www.lmt-belin.com

LMT Fette Werkzeugtechnik GmbH & Co. KG

Grabauer Strasse 24
21493 Schwarzenbek
Deutschland
Telefon +49 4151 12-0
Telefax +49 4151 3797
info@lmt-fette.com
www.lmt-fette.com

**Großbritannien und Irland/
United Kingdom**

LMT UK Ltd.
5 Elm Court
Copse Drive
Meriden
CV5 9RG
Telefon +44 1676 523440
Telefax +44 1676 525379
lmt.uk@lmt-tools.com

Indien/India

LMT (India) Private Limited
Old No. 14, New No. 29,
IInd Main Road
Gandhinagar, Adyar
Chennai – 600 020
Telefon +91 44 24405136/137
+91 44 42337701/03
Telefax +91 42337704
lmt.in@lmt-tools.com

Italien/Italy

LMT Italy S.r.l.
Via Papa Giovanni XXIII, Nr. 45
20090 Rodano (MI)
Telefon +39 02 2694971
Telefax +39 02 21872456
lmt.it@lmt-italy.it

Kanada/Canada

LMT USA Inc.
1081 S. Northpoint Blvd.
Waukegan, IL 60085
Telefon +1 847 6933270
Telefax +1 847 6933271
lmt.us@lmt-tools.com

LMT Kieninger GmbH

Vogesenstrasse 23
77933 Lahr
Deutschland
Telefon +49 7821 943-0
Telefax +49 7821 943213
info@lmt-kieninger.com
www.lmt-kieninger.com

LMT Onsrud LP

1081 S. Northpoint Blvd.
Waukegan, IL 60085
USA
Telefon +1 847 3621560
Telefax +1 847 4731934
info@lmt-onsrud.com
www.lmt-onsrud.com

Korea

LMT Korea Co. Ltd.
Room #1212, Anyang Trade
Center
1107 Bisan-Dong, Dongan-Gu,
Anyang-Si,
Gyeonggi-Do, 431-817,
South Korea
Telefon +82 31 3848600
Telefax +82 31 3842121
lmt.kr@lmt-tools.com

Mexiko/Mexico

LMT Boehlerit S.A. de C.V.
Ave. Acueducto No. 15
Parque Industrial
Bernardo Quintana
76246 El Marqués, Querétaro
Telefon +52 442 2215706
Telefax +52 442 2215555
info@lmt.com.mx

Österreich/Austria

Boehlerit GmbH & Co. KG
Werk-VI-Strasse 100
8605 Kapfenberg
Telefon +43 3862 300-0
Telefax +43 3862 300793
info@boehlerit.com

Polen/Poland

LMT Boehlerit Polska Sp.
z.o.o.
Nickel BioCentrum
Zlotniki, ul. Krzemowa 1
62-002 Suchy Las
Telefon +48 61 6593800
Telefax +48 61 6232014
lmt@lmt-polska.pl

Russland/Russia

LLC LMT Tools
Serebryanicheskaya nab., 27
109028 Moscow
Telefon +7 495 2807352
Telefax +7 495 2807352
info@lmt-russia.ru

Singapur/Singapore

LMT Asia PTE LTD.
1 Clementi Loop 04-01
Clementi West District Park
Singapur 12 9808
Telefon +65 64 624214
Telefax +65 64 624215
lmtasia@hotmail.com

**Spanien und Portugal/
Spain and Portugal**

LMT Boehlerit S.L.
C/. Narcis Monturiol 11-15
08339 Vilassar de Dalt
Barcelona
Telefon +34 93 7507907
Telefax +34 93 7507925
lmt.es@lmt-tools.com

**Tschechische Republik
und Slowakei/
Czech Republic and**

Slovakia
LMT Czech Republic s.r.o.
Dusikova 3
63800 Brno-Lesná
Telefon +420 548 218722
Telefax +420 548 218723
lmt.fette@iol.cz

in alliance

Bilz Werkzeugfabrik

GmbH & Co. KG
Vogelsangstrasse 8
73760 Ostfildern
Deutschland
Telefon +49 711 348010
Telefax +49 711 3481256
info@bilz.com
www.bilz.com

Boehlerit GmbH & Co. KG

Werk-VI-Strasse 100
8605 Kapfenberg
Österreich
Telefon +43 3862 300-0
Telefax +43 3862 300793
info@boehlerit.com
www.boehlerit.com

Türkei/Turkey

BÖHLER Sert Maden
ve Takim Sanayi ve Ticaret A.
Ankara Asfalti Üzeri No. 22,
Kartal 34873
Istanbul
Telefon +90 216 306 65 70
Telefax +90 216 306 65 74
bohler@bohler.com.tr

Ungarn/Hungary

LMT-Boehlerit Kft
Kis-Duna U. 6
2030 Erd
Po Box # 2036 Erdliget Pf. 32
Telefon +36 23 521910
Telefax +36 23 521919
lmt.hu@lmt-tools.com

USA

LMT USA Inc.
1081 S. Northpoint Blvd.
Waukegan, IL 60085
Telefon +1 847 6933270
Telefax +1 847 6933271
lmt.us@lmt-tools.com

LMT Technology Group

**BELIN
FETTE
KIENINGER
ONSRUD**

in alliance

**BILZ
BOEHLERIT**